



МОДУЛЬНЫЕ СТЕЛЛАЖНЫЕ СИСТЕМЫ

MODULAR SHELVING SYSTEMS

SCAFFALATURE MODULARI

2020/2021

МОДУЛЬНЫЕ СТЕЛЛАЖНЫЕ СИСТЕМЫ LOAD.ME

Modular Shelving Systems LOAD.ME

Scaffalature modulari LOAD.ME

Высокопрочная и функциональная модульная система стеллажей предлагает идеальные решения в области управления пространством помещений. Она обеспечивает максимально эффективное использование имеющихся площадей за счет различной комбинации стандартных модульных секций. Как система хранения, стеллажная система предназначена для холодильных и морозильных камер, кухонь, лабораторий различного назначения и других мест общего хранения. Прочная конструкция из анодированного алюминия и армированного пластика обеспечивает высокую нагрузочную способность стеллажей.

Модульная система стеллажей представлена двумя линейками:

LOAD.ME POLY – с полками из армированного полипропилена

LOAD.ME INOX – с полками из нержавеющей стали

High quality and functional modular shelving systems are ideal for managing spaces. It provides highly effective use of space due to various combinations of standard modular sections. As a storage system, modular shelving system is intended for refrigerating cameras and freezers, kitchens, various laboratories and other storage places. Its strong construction from anodized aluminum and reinforced plastic provide high load capacity of shelving.

Modular shelving is presented by two product lines:

LOAD.ME POLY – with shelves from reinforced polypropylene

LOAD.ME INOX – with shelves from stainless steel

Le scaffalature modulari solide e funzionali offrono la soluzione ideale per chi deve gestire lo spazio di stoccaggio. Garantiscono l'uso più efficiente delle superficie disponibili grazie alle varie combinazioni di sezioni modulari standard. Le scaffalature modulari sono progettate per organizzare gli spazi di stoccaggio delle celle frigorifere, tutto il settore alimentare, laboratori di diversi tipo e magazzini in genere. La robusta costruzione in alluminio anodizzato e plastica rinforzata garantisce un'elevata capacità di carico della scaffalatura.

Scaffalature modulari si presentano in due versioni:

LOAD.ME POLY – con ripiani in polipropilene rinforzato

LOAD.ME INOX – con ripiani in acciaio inox



МОДУЛЬНЫЕ СТЕЛЛАЖНЫЕ СИСТЕМЫ
Modular shelving systems / Scaffalature modulari



ПРЕДНАЗНАЧЕНЫ ДЛЯ
Are intended for: / Destinate per:

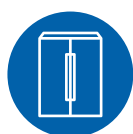

холодильных
и морозильных камер
refrigerating cameras
and freezers
celle frigorifere



лабораторий
различного назначения
various laboratories
diverse tipologie
di laboratori



медицинских
и фармацевтических предприятий
medical and pharmaceutical
enterprises
settore farmaceutico e sanitario



магазинов
shops
negozi



прачечных и других мест
общественного хранения
laundries and other places
of public storage
lavanderie e magazzini
in genere



предприятий общепита
catering enterprises
settore ristorazione pubblica

ПРИМЕНЯЕМЫЕ МАТЕРИАЛЫ

Used materials / Materiali utilizzati



Рама из экструдированного анодированного алюминиевого профиля

Frame form extruded anodized aluminum profile

Profilo strutturale in alluminio anodizzato estruso

Высокопрочные перфорированные полипропиленовые полки

Strong perforated polypropylene shelves

Robusti ripiani forati

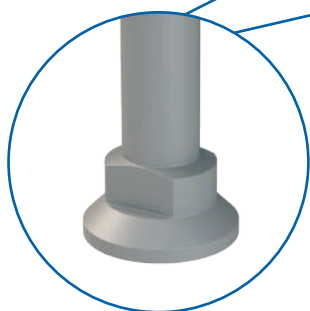
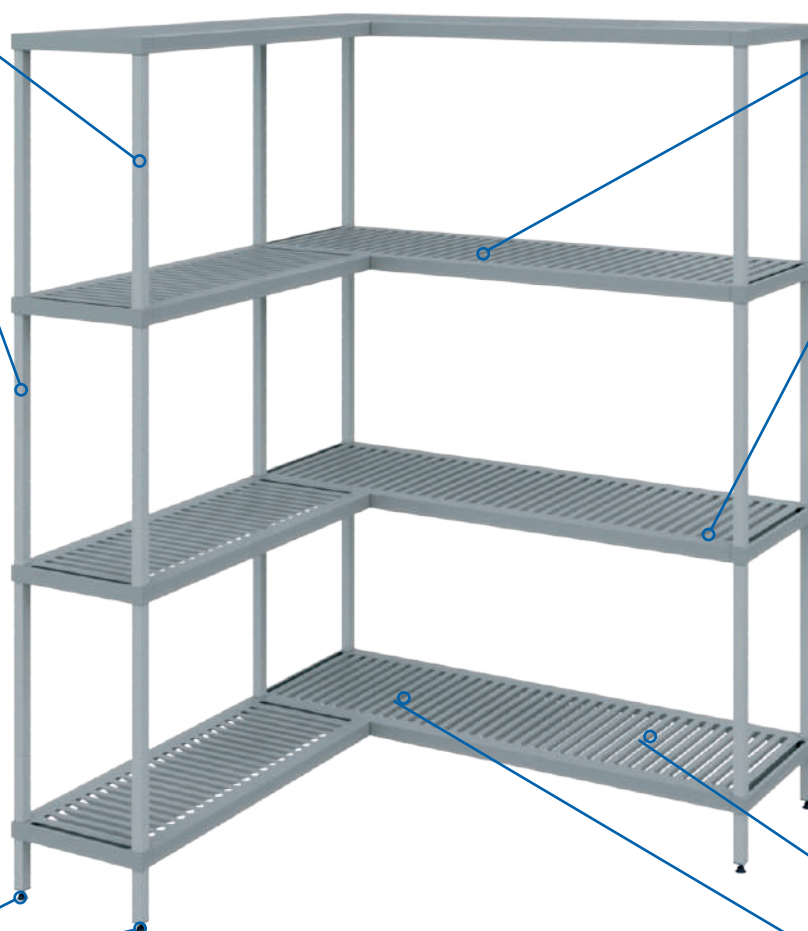
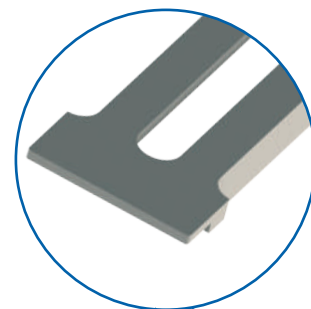

Ножки и вставки из прочного композитного сплава

Legs and inserts from composite alloy

Piedini ed inserti in dura lega composita

Возможность изготовления полок из нержавеющей стали

Possibility to produce stainless steel shelves

Ripiani in acciaio inox disponibili su richiesta

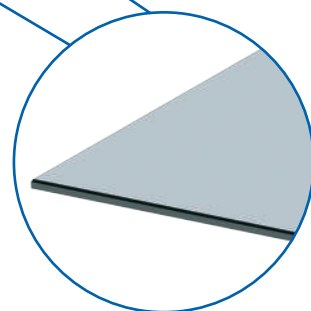

Применяемые материалы обеспечивают идеальную коррозионную стойкость и отвечают всем требованиям гигиены.

Used materials provide ideal corrosion resistance and meet hygiene requirements.

I materiali utilizzati assicurano l'ottima resistenza alla corrosione e corrispondono alla normativa igienico-sanitaria vigente

ФУНКЦИОНАЛЬНЫЕ ПРЕИМУЩЕСТВА

Functional advantages / Vantaggi funzionali



Прочность конструкции

Strong construction

Solidità della struttura



Высокая нагрузочная способность

High load capacity

Elevata portata di carico



Регулируемая высота ярусов полок

Shelf regulation 150 mm

Regulated height of tiered shelves

Adjustment step is 150 mm

Altezza regolabile dei ripiani

Con passo di regolazione di 150 mm



Сменные полки – вставки идеальны для мытья в посудомоечной машине

Removable shelves are ideal for wash in wash machine

Ripiani rimovibili lavabili anche in lavastoviglie

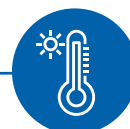

Отличная коррозионная стойкость

при температуре эксплуатации от -30°C до +80°C

High corrosion resistance at operating temperature from -30C to +80°C

Resistenza alla corrosione alla temperatura dell'esercizio da -30°C a +80°C



Скрытые крепления для обеспечения эстетики и гигиены

Hidden mounts for esthetics and hygiene

Fissaggi a scomparsa per assicurare l'estetica e l'igiene



Регулируемые ножки

Regulated legs

Piedini regolabili



Использование колесных опор для свободного перемещения стеллажа

Usage of wheel support for free movement of shelving

Disponibilità di ruote per facile spostamento

ОСНОВНЫЕ МОДУЛИ

Main modules / Elementi modulari principali

Стеллажи представляют собой универсальную модульную систему, которая предоставляет неограниченные возможности застройки помещения. Различные комбинации модулей стеллажей от одной секции до сложных конструктивных компоновок форм «L», «U», «Т» позволяют расположить стеллажи в помещении оптимально и эффективно, учитывая все требования заказчика.

Modular shelving is a multipurpose modular system providing unlimited possibilities for premises organizing. Various combinations of shelving modules from one section to complex constructive arrangements of L, U and T forms enable effective location of shelving taking into consideration all requirements of the customer.

Le scaffalature sono un sistema modulare universale che offre illimitate possibilità di organizzazione dello spazio di stoccaggio. Varie combinazioni di scaffali da una singola campata alle complesse forme costruttive a forma di «L», «U», «Т» permettono di posizionarli in modo ottimale, efficiente ed adattabile per ogni locale



СХЕМА УСЛОВНЫХ ОБОЗНАЧЕНИЙ

Designation of the rack section / Legenda codifiche scaffalatura

18AL.3PP40.15B

↓ ↓ ↓ ↓ ↓ ↓ ↓
1 2 3 4 5 6 7

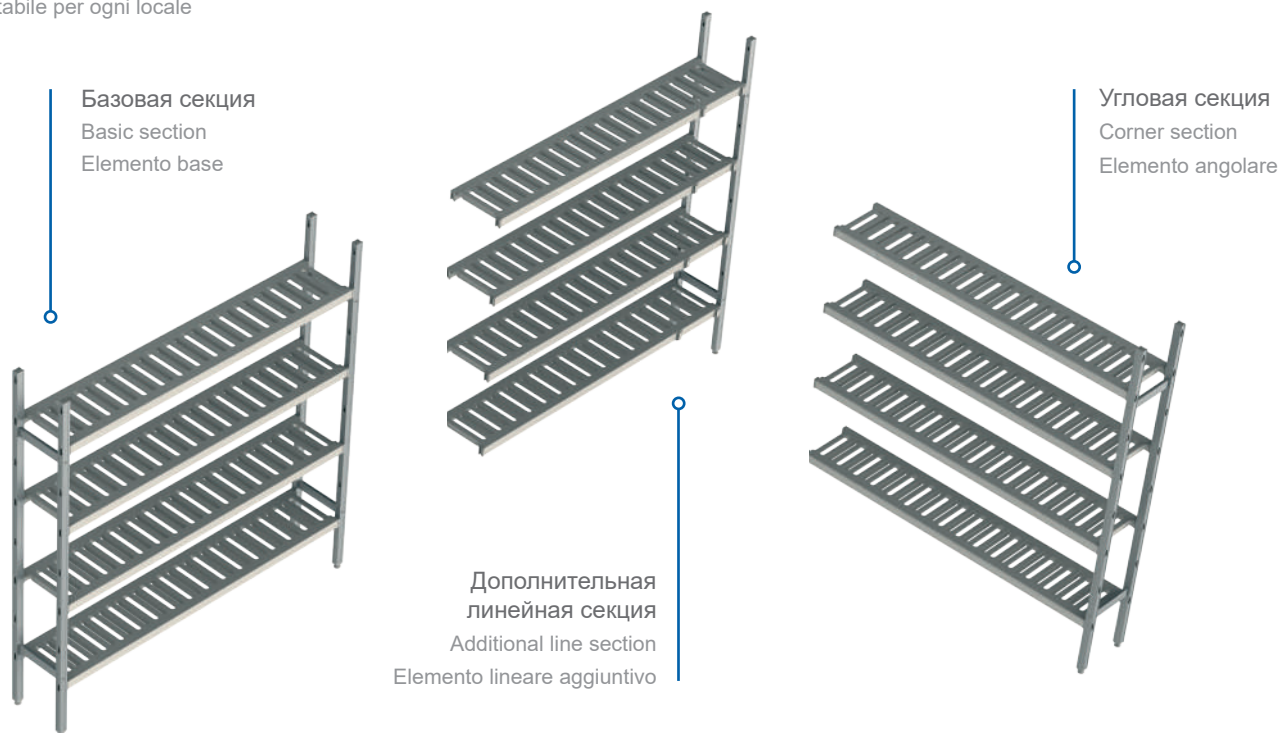
16AL.5PP30.10E

↓ ↓ ↓ ↓ ↓ ↓ ↓
1 2 3 4 5 6 7

21AL.4IN50.12C

↓ ↓ ↓ ↓ ↓ ↓ ↓
1 2 3 4 5 6 7

- 1 высота секции, где 16 - 1600 мм, 18 - 1800 мм, 21 - 2100 мм
section height, where 16 - 1600 mm, 18 - 1800 mm, 21 - 2100 mm
altezza dello scaffale, dove 16 - 1600 mm, 18 - 1800 mm, 21 - 2100 mm
- 2 материал стеллажной рамы, где AL – алюминий
rack frame material, where AL – aluminum
materiale della struttura portante, dove AL – alluminio
- 3 количество ярусов полок
number of shelves tiers
numero di livelli
- 4 материал полок, где
PP – полипропилен, IN – нержавеющая сталь
shelf material, where PP – polypropylene, IN – stainless steel
materiale de lriplanio, dove PP – polipropilene, IN – acciaioinossidabile
- 5 глубина стеллажа, где 30 – 300 мм, 40 – 400 мм, 50 – 500 мм
rack depth, where 30 – 300 mm, 40 – 400 mm, 50 – 500 mm
profondità dello scaffale, dove 30 – 300 mm, 40 – 400 mm, 50 – 500 mm
- 6 длина секции, где
06...18 – от 600 до 1800 мм
section length, where 06...18 – from 600 till 1800 mm
lunghezza dello scaffale, dove 06...18 – da 600 a 1800 mm
- 7 вид стеллажной секции, где
B – базовая секция
E – дополнительная линейная секция
C – угловая секция
section type, where
B – basic section
E – additional line section
C – corner section
modello di scaffale, dove
B – elemento base
E – elemento lineare aggiuntivo
C – elemento angolare

РАЗМЕРНЫЙ РЯД МОДУЛЕЙ

Size range of modules / Dimensioni di scaffali modulari

A	660	760	860	960	1060	1160	1260	1360	1460	1560	1660	1760	1860
B	630	730	830	930	1030	1130	1230	1330	1430	1530	1630	1730	1830
B1	630	730	830	930	1030	1130	1230	1330	1430	1530	1630	1730	1830
C	600	700	800	900	1000	1100	1200	1300	1400	1500	1600	1700	1800
D	300	400	500	550*									

*Вариант исполнения под габаритности GN

*Execution option for gastronorm container GN / *Versione per l'uso di contenitori gastronorm GN

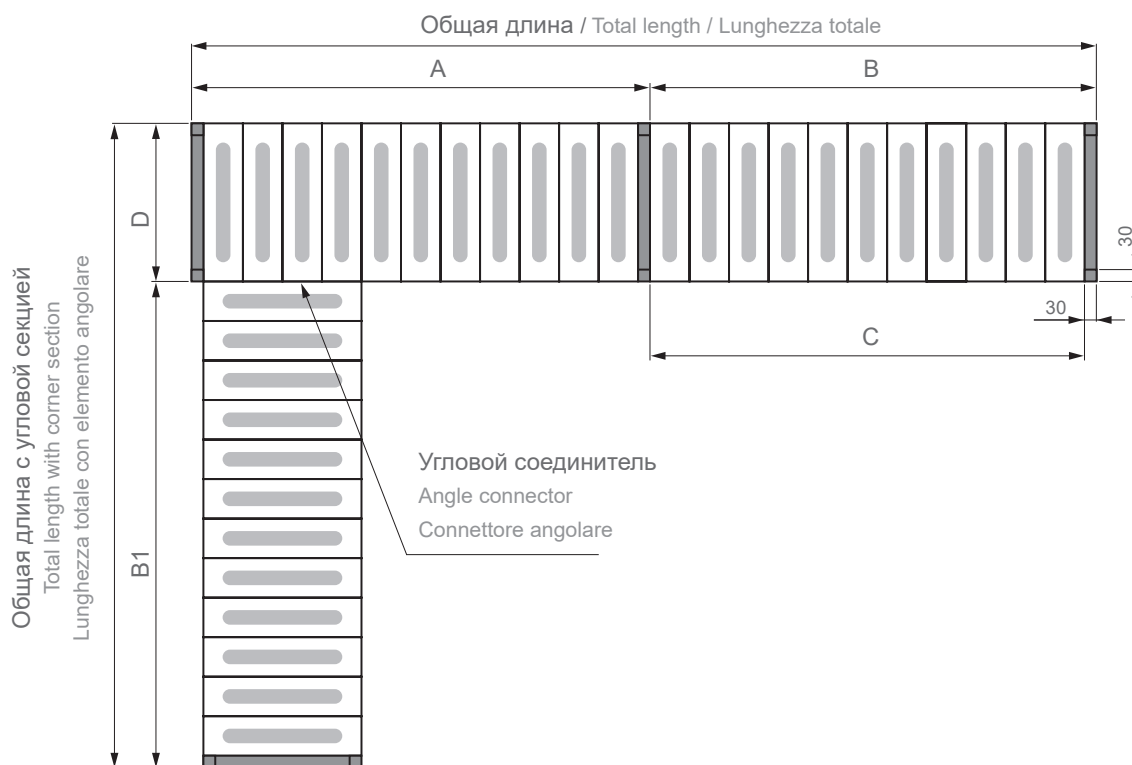

Длина, мм Length, mm Lunghezza, mm	600	700	800	900	1000	1100	1200	1300	1400	1500	1600	1700	1800
	190	170	150	130	120	110	100	95	90	80	75	70	65

ЦВЕТОВОЕ РЕШЕНИЕ ПОЛОК

Color options for shelves / Colori dei ripiani

Стандартное решение:

Standard solution:

Colore standard:



Допустимое решение:

Additional solution:

Colori disponibili su richiesta:



Идеально для визуализации зон хранения продукции с различными сроками годности с целью обеспечения требований стандартов FIFO и HACCP.

They are ideal to visualize the storage areas of products with different expiring dates according to FIFO and HACCP standards requirements / Ideale per evidenziare le aree di stoccaggio di prodotti con diverse date di scadenze nel rispetto del protocollo FIFO e del sistema HACCP

ВАРИАНТЫ КОМПОНОВКИ СТЕЛЛАЖЕЙ

Shelving layout options / Esempi di composizioni scaffalature

Базовая секция

Basic section

Elemento base

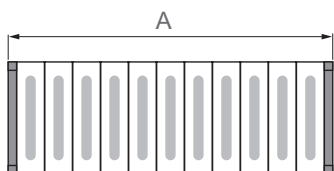

Базовая секция + дополнительная линейная секция

Basic section + additional line section

Elemento base + elemento lineare aggiuntivo

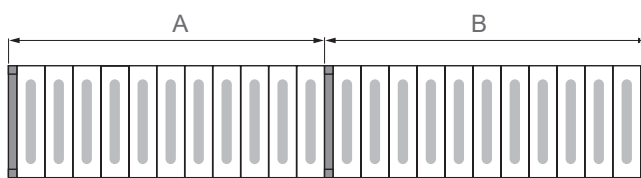

Базовая секция + угловая секция

Basic section + corner section

Elemento base + elemento angolare

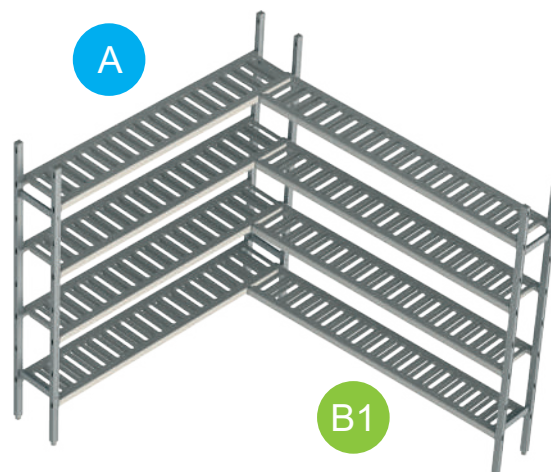
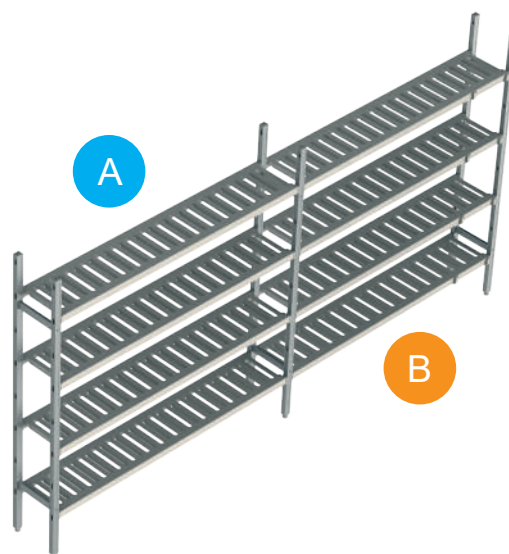
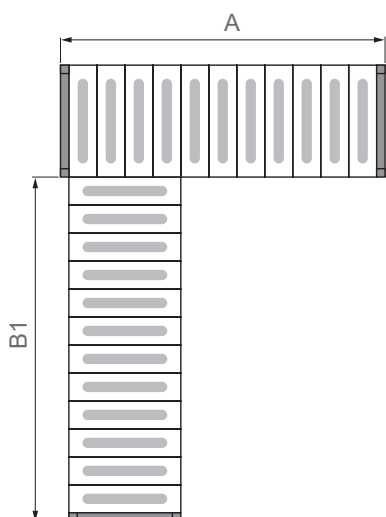

Базовая секция + дополнительная линейная и угловая секции

Basic section + additional line and corner sections

Elemento base + elementi aggiuntivi lineare ed angolare

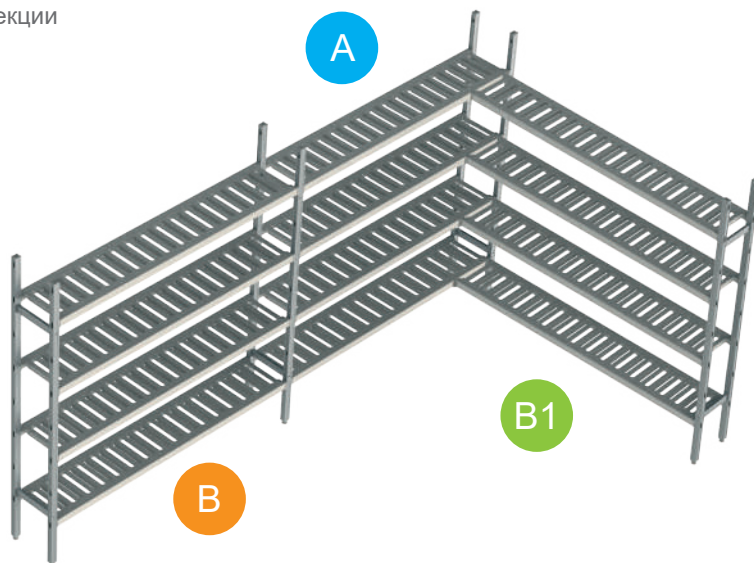
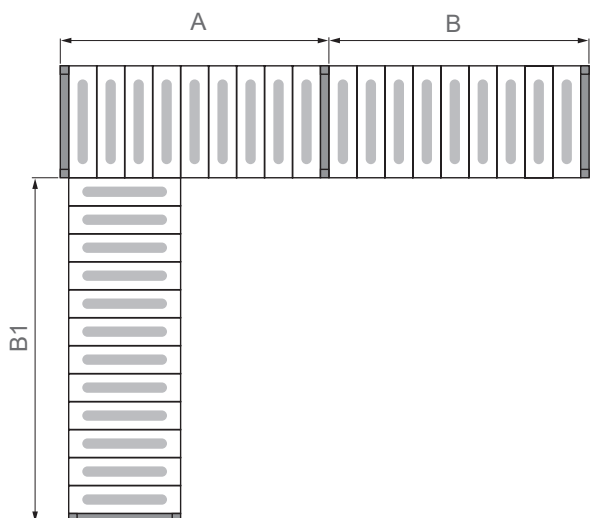

Две базовые секции + дополнительная линейная с фиксацией с двух сторон

Two basic sections + additional line section with two-side fixation

Due elementi base + elemento aggiuntivo lineare fissato da due lati

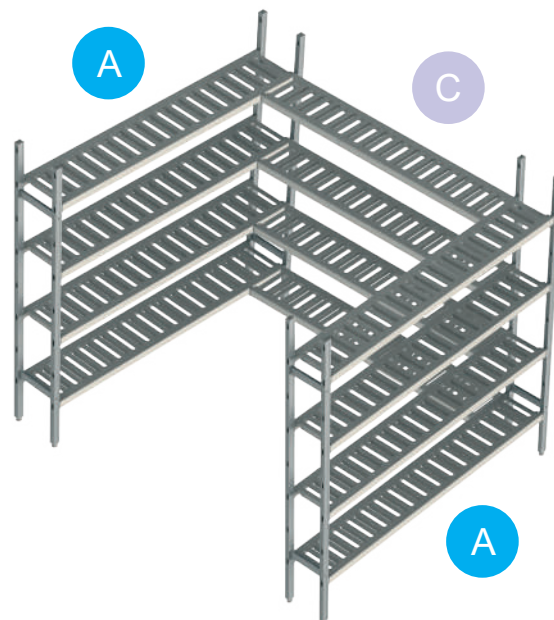
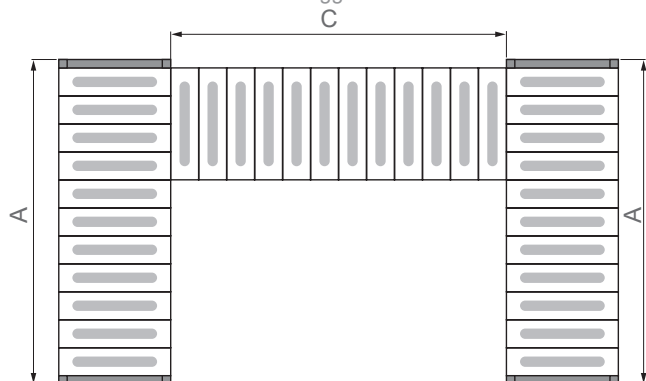

Базовая + две угловые секции

Basic section + two corner sections

Elemento base + due elementi angolari

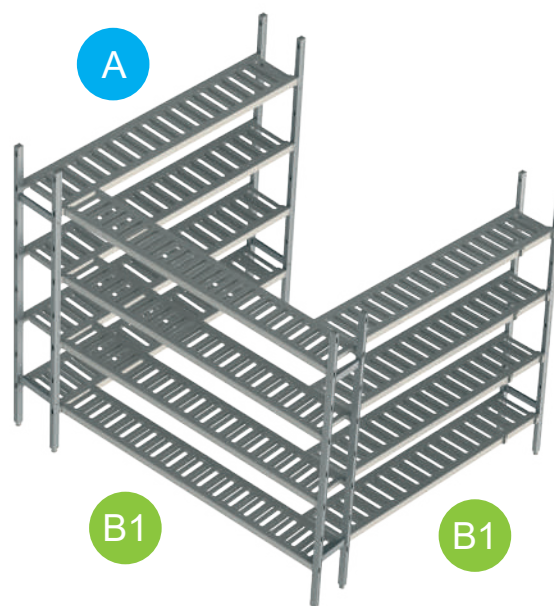
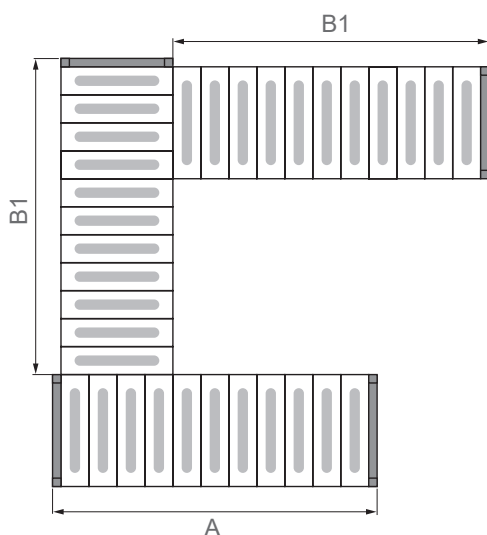



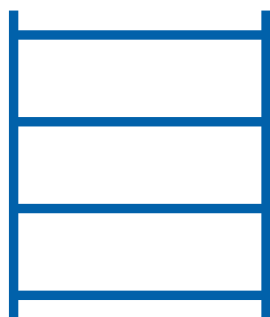

СТРУКТУРА МОДУЛЬНОЙ СТЕЛЛАЖНОЙ СИСТЕМЫ

MODULAR SHELVING SYSTEM
STRUCTURE

SISTEMA DI SCAFFALATURE
MODULARE

ОСНОВНЫЕ СБОРОЧНЫЕ УЗЛЫ СТЕЛЛАЖНОЙ СИСТЕМЫ

The main assembly units of the shelving system / I componenti principali del sistema di scaffalature

ЛЕСТНИЦА (сб)

Комплектация:

- стойки – 2 шт
- траверсы – 3 шт
- винтовые ножки-опоры – 2шт
- заглушки – 2 шт
- винт 4,8x38 – 4 шт

End side (preassembled)

Equipped with:

- 2 racks
- 3 traversas
- 2 screw supports
- 2 rack covers
- 4 screws 4,8x38

Struttura portante «scala»
(già assemblata)

Composta di:

- 2 pz montanti
- 3 pz barre trasversali
- 2 pz piedini a vite
- 2 pz tappi di chiusura montanti
- 4 pz viti 4,8x38



Артикул Article Articolo	Высота H, мм Height H, mm Altezza H, m	Глубина D, мм Depth D, mm Profondità D, mm	Цена, руб. Price, rubles Prezzo, rubli
16 AI 30F	1600		1 835
18 AI 30F	1800	300	2 017
21 AI 30F	2100		2 289
16 AI 40F	1600		1 961
18 AI 40F	1800	400	2 142
21 AI 40F	2100		2 414
16 AI 50F	1600		2 086
18 AI 50F	1800	500	2 267
21 AI 50F	2100		2 539

2

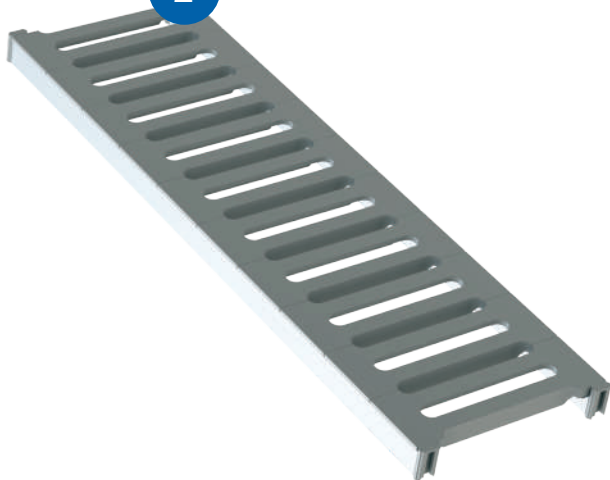

ПОЛКА (сб) POLY

Комплектация полки (сб) базовой и дополнительной линейной секции:

- полка B=100 мм в количестве соответствующей длине секции (количество полок = L секции /100)
- перекладина горизонтальная длиной соответствующей длине секции – 2 шт
- торец перекладины – 4 шт
- крюк – 4 шт

Комплектация полки (сб) угловой секции:

- полка B=100 мм в количестве соответствующей длине секции (количество полок = L секции/100)
- перекладина горизонтальная длиной соответствующей длине полки – 2 шт
- торец перекладины – 4 шт
- крюк – 2 шт
- соединитель угловой – 2 шт

Shelf (preassembled) POLY

The shelf (preassembled) for basic and additional sections are equipped with:

- shelf B=100 mm in the amount corresponding to the length of the section (shelf's quantity = section L/100)
- 2 horizontal crossbars length corresponding to the length of the shelf
- 4 crossbar ends
- 4 steel hooks

The corner section (preassembled) is equipped with:

- shelf B=100 mm in the amount corresponding to the length of the section (quantity of shelf's = section's L/100)
- 2 horizontal crossbars length corresponding to the length of the shelf
- 4 crossbar ends
- 2 steel hooks
- 2 angle steel hooks

Shelf (preassembled) POLY

Per l'elemento base ed l'elemento lineare aggiuntivo è composto di:

- sezioni di larghezza a 100 mm per assemblare il ripiano; il numero di sezioni dipenderà dalla lunghezza del ripiano (n° sezioni = L ripiano/100)
- 2 pz trasversa orizzontale; la sua lunghezza corrisponde alla lunghezza del ripiano
- 4 pz estremità per la traversa
- 4 pz gancio

Per l'elemento angolare aggiuntivo è composto di:

- sezioni di larghezza a 100 mm per assemblare il ripiano; il numero di sezioni dipenderà dalla lunghezza del ripiano (n° sezioni = L ripiano/100)
- 2 pz trasversa orizzontale; la sua lunghezza corrisponde alla lunghezza del ripiano
- 4 pz estremità per la traversa
- 2 pz gancio
- 2 pz connettore angolare

Артикул полки (сб) POLY базовой и дополнительной линейной секции POLY Shelf (preassembled) article of the based and additional section Articolo ripiano (SB) POLY di base e sezione lineare aggiuntiva	Артикул полки (сб) POLY угловой секции POLY Shelf (preassembled) article of the corner section Articolo ripiano (SB) POLY sezione angolare	Длина, мм Length, mm Lunghezza, mm	Глубина, мм Depth, mm Profondità, mm	Цена, руб. Price, rubles Prezzo, rubli	
06 PP 30S	06 PP 30C	600	300	1 070	
07 PP 30S	07 PP 30C	700		1 212	
08 PP 30S	08 PP 30C	800		1 354	
09 PP 30S	09 PP 30C	900		1 496	
10 PP 30S	10 PP 30C	1000		1 638	
11 PP 30S	11 PP 30C	1100		1 780	
12 PP 30S	12 PP 30C	1200		1 922	
13 PP 30S	13 PP 30C	1300		2 064	
14 PP 30S	14 PP 30C	1400		2 206	
15 PP 30S	15 PP 30C	1500		2 348	
16 PP 30S	16 PP 30C	1600		2 490	
17 PP 30S	17 PP 30C	1700		2 632	
18 PP 30S	18 PP 30C	1800		2 774	
06 PP 40S	06 PP 40C	600		400	1 080
07 PP 40S	07 PP 40C	700			1 223
08 PP 40S	08 PP 40C	800			1 366
09 PP 40S	09 PP 40C	900			1 509
10 PP 40S	10 PP 40C	1000			1 651
11 PP 40S	11 PP 40C	1100	1 794		
12 PP 40S	12 PP 40C	1200	1 937		
13 PP 40S	13 PP 40C	1300	2 080		
14 PP 40S	14 PP 40C	1400	2 223		
15 PP 40S	15 PP 40C	1500	2 361		
16 PP 40S	16 PP 40C	1600	2 509		
17 PP 40S	17 PP 40C	1700	2 662		
18 PP 40S	18 PP 40C	1800	2 795		
06 PP 50S	06 PP 50C	600	500		1 120
07 PP 50S	07 PP 50C	700			1 279
08 PP 50S	08 PP 50C	800			1 438
09 PP 50S	09 PP 50C	900			1 597
10 PP 50S	10 PP 50C	1000			1 756
11 PP 50S	11 PP 50C	1100		1 915	
12 PP 50S	12 PP 50C	1200		2 074	
13 PP 50S	13 PP 50C	1300		2 233	
14 PP 50S	14 PP 50C	1400		2 392	
15 PP 50S	15 PP 50C	1500		2 551	
16 PP 50S	16 PP 50C	1600		2 710	
17 PP 50S	17 PP 50C	1700		2 869	
18 PP 50S	18 PP 50C	1800		3 028	

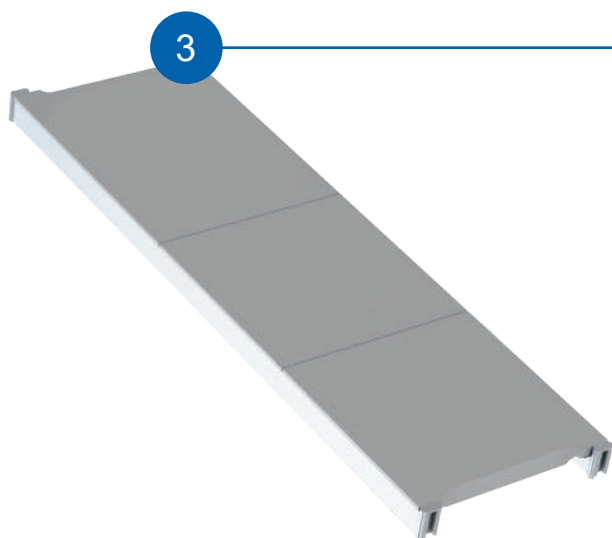
**ПОЛКА (сб) INOX**

Комплектация базовой и дополнительной линейной секции:

- полки из нержавеющей стали размерами и в количестве соответствующей длине полки в сборе
- переключатель горизонтальная длиной соответствующей длине полки – 2 шт
- торец переключателя – 4 шт
- крюк – 4 шт

Комплектация угловой секции:

- полки из нержавеющей стали размерами и в количестве соответствующей длине полки в сборе
- переключатель горизонтальная длиной соответствующей длине полки – 2 шт
- торец переключателя – 2 шт
- крюк – 2 шт
- соединитель угловой – 2 шт

Shelf (preassembled) INOX

The shelf (preassembled) for basic and additional sections are equipped with:

- stainless steel shelves in size and quantity corresponding to the length of the section
- 2 horizontal crossbars length corresponding to the length of the shelf
- 4 crossbar ends
- 4 steel hooks

The corner section (preassembled) is equipped with:

- stainless steel shelves in size and quantity corresponding to the length of the section
- 2 horizontal crossbars length corresponding to the length of the shelf
- 4 crossbar ends
- 2 steel hooks
- 2 angle steel hooks

Shelf (preassembled) INOX

Per l'elemento base ed l'elemento lineare aggiuntivo è composto di:

- mensole in acciaio INOX di dimensioni e nella quantità corrispondente alla lunghezza della sezione
- 2 pz trasversa orizzontale; la sua lunghezza corrisponde alla lunghezza del ripiano
- 4 pz estremità per la traversa
- 4 pz gancio

Per l'elemento angolare aggiuntivo è composto di:

- mensole in acciaio INOX di dimensioni e nella quantità corrispondente alla lunghezza della sezione
- 2 pz trasversa orizzontale; la sua lunghezza corrisponde alla lunghezza del ripiano
- 2 pz estremità per la traversa
- 2 pz gancio
- 2 pz connettore angolare

Артикул полки (сб) INOX базовой и дополнительной линейной секции INOX Shelf (preassembled) article of the based and additional section Articolo ripiano (SB) INOX di base e sezione lineare aggiuntiva	Артикул полки (сб) INOX угловой секции INOX Shelf (preassembled) article of the corner section Articolo ripiano (SB) INOX sezione angolare	Длина, мм Length, mm Lunghezza, mm	Глубина, мм Depth, mm Profondità, mm	Размер полки, входящей в сборку, мм Shelf's size included in the kit, mm Dimensione del ripiano incluso nell'assieme, mm	Количество полок, входящих в сборку The number of shelves included in the kit Numero di ripiani inclusi nell'assieme	Цена, руб. Price, rubles Prezzo, rubli
06 IN 30S	06 IN 30C	600	300	300x300	2	1 679
07 IN 30S	07 IN 30C	700		300x300 400x300	1 1	1 881
08 IN 30S	08 IN 30C	800		400x300	2	2 072
09 IN 30S	09 IN 30C	900		300x300	3	2 367
10 IN 30S	10 IN 30C	1000		300x300 400x300	2 1	2 569
11 IN 30S	11 IN 30C	1100		300x300 400x300	1 2	2 767
12 IN 30S	12 IN 30C	1200		400x300	3	2 973
13 IN 30S	13 IN 30C	1300		300x300 400x300	3 1	3 258
14 IN 30S	14 IN 30C	1400		300x300 400x300	2 2	3 460
15 IN 30S	15 IN 30C	1500		300x300 400x300	1 3	3 661

Артикул полки (сб) INOX базовой и дополнительной линейной секции INOX Shelf (preassembled) article of the based and additional section Articolo ripiano (SB) INOX di base e sezione lineare aggiuntiva	Артикул полки (сб) INOX угловой секции INOX Shelf (preassembled) article of the corner section Articolo ripiano (SB) INOX sezione angolare	Длина, мм Length, mm Lunghezza, mm	Глубина, мм Depth, mm Profondità, mm	Размер полки, входящей в сборку, мм Shelf's size included in the kit, mm Dimensione del ripiano incluso nell'assieme, mm	Количество полок, входящих в сборку The number of shelves included in the kit Numero di ripiani inclusi nell'assieme	Цена, руб. Price, rubles Prezzo, rubli	
16 IN 30S	16 IN 30C	1600	300	400x300	4	3 863	
17 IN 30S	17 IN 30C	1700		300x300 400x300	3 2	4 148	
18 IN 30S	18 IN 30C	1800		300x300 400x300	2 3	4 350	
06 IN 40S	06 IN 40C	600	400	300x400	2	1 914	
07 IN 40S	07 IN 40C	700		300x400 400x400	1 1	2 135	
08 IN 40S	08 IN 40C	800		400x400	2	2 357	
09 IN 40S	09 IN 40C	900		300x400	3	2 720	
10 IN 40S	10 IN 40C	1000		300x400 400x400	2 1	2 941	
11 IN 40S	11 IN 40C	1100		300x400 400x400	1 2	3 163	
12 IN 40S	12 IN 40C	1200		400x400	3	3 384	
13 IN 40S	13 IN 40C	1300		300x400 400x400	3 1	3 747	
14 IN 40S	14 IN 40C	1400		300x400 400x400	2 2	3 969	
15 IN 40S	15 IN 40C	1500		300x400 400x400	1 3	4 190	
16 IN 40S	16 IN 40C	1600		400x400	4	4 412	
17 IN 40S	17 IN 40C	1700		300x400 400x400	3 2	4 775	
18 IN 40S	18 IN 40C	1800		300x400 400x400	2 3	4 996	
06 IN 50S	06 IN 50C	600		500	300x500	2	2 155
07 IN 50S	07 IN 50C	700			300x500 400x500	1 1	2 439
08 IN 50S	08 IN 50C	800			400x500	2	2 722
09 IN 50S	09 IN 50C	900			300x500	3	3 082
10 IN 50S	10 IN 50C	1000			300x500 400x500	2 1	3 365
11 IN 50S	11 IN 50C	1100	300x500 400x500		1 2	3 649	
12 IN 50S	12 IN 50C	1200	400x500		3	3 932	
13 IN 50S	13 IN 50C	1300	300x500 400x500		3 1	4 292	
14 IN 50S	14 IN 50C	1400	300x500 400x500		2 2	4 575	
15 IN 50S	15 IN 50C	1500	300x500 400x500		1 3	4 859	
16 IN 50S	16 IN 50C	1600	400x500		4	5 142	
17 IN 50S	17 IN 50C	1700	300x500 400x500		3 2	5 502	
18 IN 50S	18 IN 50C	1800	300x500 400x500	2 3	5 785		

МОНТАЖНЫЕ ЭЛЕМЕНТЫ

Mounting elements / Componenti di assemblaggio

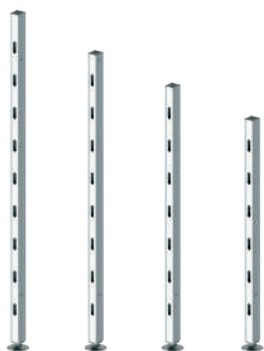
**Стойка
из анодированного алюминия**Rack from anodized aluminum
Montante in alluminio anodizzato

Артикул	Высота, мм	Цена, руб.
RAC 1600	1600	1 700
RAC 1800	1800	1 900
RAC 2100	2100	2 200
RAC 2400	2400	2 500

**Траверса**Traversa
Traversa

Артикул	Длина, мм	Цена, руб.
TRA 300	300	200
TRA 400	400	250
TRA 500	500	300

**Полка из полипропилена**Polypropylene shelf
Ripiano in polipropilene

Артикул	Глубина, мм	Цена, руб.
PP 100.300	300	200
PP 100.400	400	250
PP 100.500	500	300

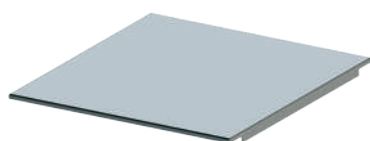
**Полка из нержавеющей стали**Stainless steel shelf
Ripiano in acciaio Inox

Артикул	Размеры, мм	Цена, руб.
IN 300.300	300x300	700
IN 400.300	400x300	900
IN 300.400	300x400	950
IN 400.400	400x400	1 200
IN 300.500	300x500	1 100
IN 400.300	400x500	1 500



**Крюк из стали
с защитным покрытием**

Steel hook with protective coating
Gancio in acciaio con rivestimento
protettivo

Артикул	Цена, руб.
SHS 001	90



**Крюк угловой
из стали с защитным покрытием**

Steel angle hook with protective coating
Gancio angolare in acciaio
con rivestimento protettivo

Артикул	Цена, руб.
SHA 001	120



**Винтовая опора в сборе из
высокопрочного композитного
материала**

Assembles screw support from
lasting composed material
Gruppo supporto-piede a vite
in materiale composito di alta resistenza

Артикул	Цена, руб.
ASS 001	150

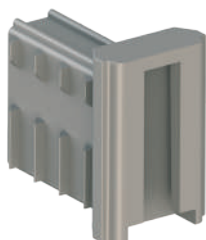

**Торец перекладины
из композитного материала**

Butt of crossbar
from composed material
Estremità della barra trasversale
in materiale composito

Артикул	Цена, руб.
BUC 001	90

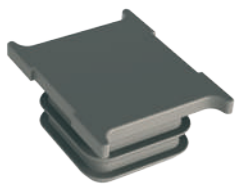

Заглушка стойки из композитного материала

Rack cover from composed material
Tappo di chiusura in materiale composito
per il montante

Артикул	Цена, руб.
RAC 001	50



Переключатель горизонтальная (сб) из анодированного алюминия

Horizontal crossbar from
anodized aluminum
Traversa orizzontale
in alluminio anodizzato

Артикул	Размеры, мм	Цена, руб.
НОС 600	600	560
НОС 700	700	650
НОС 800	800	740
НОС 900	900	830
НОС 1000	1000	920
НОС 1100	1100	1 010
НОС 1200	1200	1 100
НОС 1300	1300	1 190
НОС 1400	1400	1 280
НОС 1500	1500	1 370
НОС 1600	1600	1 460
НОС 1700	1700	1 550
НОС 1800	1800	1 640

ОПЦИИ

Options / Opzioni



Перегородка стандартная (сб.)

Standard partition

Barra divisoria standard

Артикул	Размеры, мм	Цена, руб.
STP 300	300	330
STP 400	400	410
STP 500	500	490
STP 600	600	570
STP 700	700	650
STP 800	800	730
STP 900	900	810
STP 1000	1000	890
STP 1100	1100	970
STP 1200	1200	1 050
STP 1300	1300	1 130
STP 1400	1400	1 210
STP 1500	1500	1 290
STP 1600	1600	1 370
STP 1700	1700	1 450
STP 1800	1800	1 530



Перегородка легкая (сб.)

Light partition

Barra divisoria leggera

Артикул	Размеры, мм	Цена, руб.
LIP 300	300	270
LIP 400	400	340
LIP 500	500	410
LIP 600	600	480
LIP 700	700	550
LIP 800	800	620
LIP 900	900	690
LIP 1000	1000	760
LIP 1100	1100	830
LIP 1200	1200	900
LIP 1300	1300	970
LIP 1400	1400	1 040
LIP 1500	1500	1 110
LIP 1600	1600	1 180
LIP 1700	1700	1 250
LIP 1800	1800	1 320



Кронштейн (крепление стеллажа к стене) (сб)

Bracket
(wall mounting of shelving)
Supporto
(per fissaggio dello scaffale al muro)

Артикул	Цена, руб.
BPA 001	900



Фиксатор ножки к полу из стали с защитным покрытием

Steel leg fixer to the floor with
protective coating
Rondellain acciaio con rivestimento protettivo
per fissare il piede al pavimento

Артикул	Цена, руб.
SFL 001	400



Торец перегородки из композитного материала

But of partition
from composed material
Estremità della barra divisoria
in materiale composito

Артикул	Цена, руб.
BUP 001	90



Колесная опора

Wheel support
Set di ruote

Артикул	Цена, руб.
WHE 001	500



ПРАЙС-ЛИСТЫ

PRICE LISTS

LISTINI PREZZI

H. 1600
D. 300

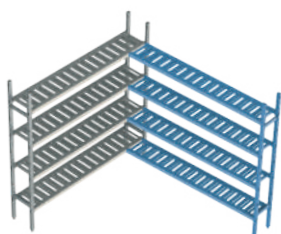
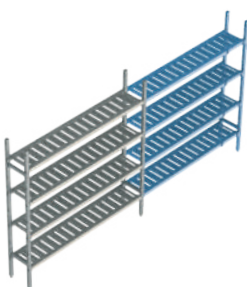
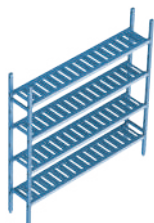

Общая длина, мм Total length, mm Lunghezza totale, mm	Длина полки, мм Shelf length, mm Lunghezza ripiano, mm	Цена, руб. / Price, rubles / Prezzo, rubli					
		3 яруса / 3 tiers / 3 livelli		4 яруса / 4 tiers / 4 livelli		5 ярусов / 5 tiers / 5 livelli	
Базовая секция Basic section / Elemento base							
660	600	16AL.3PP30.06B	6 692	16AL.4PP30.06B	7 805	16AL.5PP30.06B	8 919
760	700	16AL.3PP30.07B	7 118	16AL.4PP30.07B	8 374	16AL.5PP30.07B	9 630
860	800	16AL.3PP30.08B	7 545	16AL.4PP30.08B	8 943	16AL.5PP30.08B	10 340
960	900	16AL.3PP30.09B	7 971	16AL.4PP30.09B	9 511	16AL.5PP30.09B	11 051
1060	1000	16AL.3PP30.10B	8 397	16AL.4PP30.10B	10 080	16AL.5PP30.10B	11 762
1160	1100	16AL.3PP30.11B	8 824	16AL.4PP30.11B	10 648	16AL.5PP30.11B	12 473
1260	1200	16AL.3PP30.12B	9 250	16AL.4PP30.12B	11 217	16AL.5PP30.12B	13 183
1360	1300	16AL.3PP30.13B	9 677	16AL.4PP30.13B	11 785	16AL.5PP30.13B	13 894
1460	1400	16AL.3PP30.14B	10 103	16AL.4PP30.14B	12 354	16AL.5PP30.14B	14 605
1560	1500	16AL.3PP30.15B	10 530	16AL.4PP30.15B	12 922	16AL.5PP30.15B	15 315
1660	1600	16AL.3PP30.16B	10 956	16AL.4PP30.16B	13 491	16AL.5PP30.16B	16 026
1760	1700	16AL.3PP30.17B	11 382	16AL.4PP30.17B	14 060	16AL.5PP30.17B	16 737
1860	1800	16AL.3PP30.18B	11 809	16AL.4PP30.18B	14 628	16AL.5PP30.18B	17 447
Дополнительная линейная секция Additional line section / Elemento lineare aggiuntivo							
630	600	16AL.3PP30.06E	4 747	16AL.4PP30.06E	5 861	16AL.5PP30.06E	6 976
730	700	16AL.3PP30.07E	5 174	16AL.4PP30.07E	6 430	16AL.5PP30.07E	7 687
830	800	16AL.3PP30.08E	5 600	16AL.4PP30.08E	6 999	16AL.5PP30.08E	8 398
930	900	16AL.3PP30.09E	6 027	16AL.4PP30.09E	7 569	16AL.5PP30.09E	9 110
1030	1000	16AL.3PP30.10E	6 454	16AL.4PP30.10E	8 138	16AL.5PP30.10E	9 821
1130	1100	16AL.3PP30.11E	6 881	16AL.4PP30.11E	8 707	16AL.5PP30.11E	10 532
1230	1200	16AL.3PP30.12E	7 308	16AL.4PP30.12E	9 276	16AL.5PP30.12E	11 243
1330	1300	16AL.3PP30.13E	7 734	16AL.4PP30.13E	9 845	16AL.5PP30.13E	11 954
1430	1400	16AL.3PP30.14E	8 161	16AL.4PP30.14E	10 414	16AL.5PP30.14E	12 666
1530	1500	16AL.3PP30.15E	8 588	16AL.4PP30.15E	10 983	16AL.5PP30.15E	13 377
1630	1600	16AL.3PP30.16E	9 015	16AL.4PP30.16E	11 552	16AL.5PP30.16E	14 088
1730	1700	16AL.3PP30.17E	9 442	16AL.4PP30.17E	12 121	16AL.5PP30.17E	14 799
1830	1800	16AL.3PP30.18E	9 869	16AL.4PP30.18E	12 690	16AL.5PP30.18E	15 510
Угловая секция Corner section / Elemento angolare							
630	600	16AL.3PP30.06C	4 747	16AL.4PP30.06C	5 861	16AL.5PP30.06C	6 976
730	700	16AL.3PP30.07C	5 174	16AL.4PP30.07C	6 430	16AL.5PP30.07C	7 687
830	800	16AL.3PP30.08C	5 600	16AL.4PP30.08C	6 999	16AL.5PP30.08C	8 398
930	900	16AL.3PP30.09C	6 027	16AL.4PP30.09C	7 569	16AL.5PP30.09C	9 110
1030	1000	16AL.3PP30.10C	6 454	16AL.4PP30.10C	8 138	16AL.5PP30.10C	9 821
1130	1100	16AL.3PP30.11C	6 881	16AL.4PP30.11C	8 707	16AL.5PP30.11C	10 532
1230	1200	16AL.3PP30.12C	7 308	16AL.4PP30.12C	9 276	16AL.5PP30.12C	11 243
1330	1300	16AL.3PP30.13C	7 734	16AL.4PP30.13C	9 845	16AL.5PP30.13C	11 954
1430	1400	16AL.3PP30.14C	8 161	16AL.4PP30.14C	10 414	16AL.5PP30.14C	12 666
1530	1500	16AL.3PP30.15C	8 588	16AL.4PP30.15C	10 983	16AL.5PP30.15C	13 377
1630	1600	16AL.3PP30.16C	9 015	16AL.4PP30.16C	11 552	16AL.5PP30.16C	14 088
1730	1700	16AL.3PP30.17C	9 442	16AL.4PP30.17C	12 121	16AL.5PP30.17C	14 799
1830	1800	16AL.3PP30.18C	9 869	16AL.4PP30.18C	12 690	16AL.5PP30.18C	15 510

H. 1600
D. 400

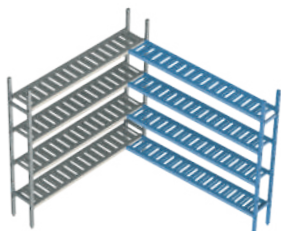
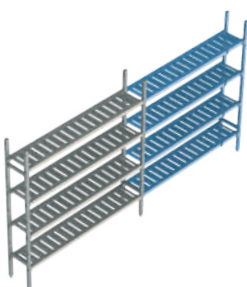
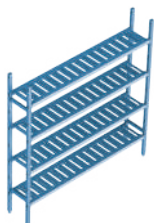

Общая длина, мм Total length, mm Lunghezza totale, mm	Длина полки, мм Shelf length, mm Lunghezza ripiano, mm	Цена, руб. / Price, rubles / Prezzo, rubli					
		3 яруса / 3 tiers / 3 livelli		4 яруса / 4 tiers / 4 livelli		5 ярусов / 5 tiers / 5 livelli	
Базовая секция Basic section / Elemento base							
660	600	16AL.3PP40.06B	6 878	16AL.4PP40.06B	7 996	16AL.5PP40.06B	9 115
760	700	16AL.3PP40.07B	7 307	16AL.4PP40.07B	8 568	16AL.5PP40.07B	9 829
860	800	16AL.3PP40.08B	7 736	16AL.4PP40.08B	9 140	16AL.5PP40.08B	10 544
960	900	16AL.3PP40.09B	8 164	16AL.4PP40.09B	9 711	16AL.5PP40.09B	11 258
1060	1000	16AL.3PP40.10B	8 593	16AL.4PP40.10B	10 283	16AL.5PP40.10B	11 973
1160	1100	16AL.3PP40.11B	9 022	16AL.4PP40.11B	10 855	16AL.5PP40.11B	12 688
1260	1200	16AL.3PP40.12B	9 451	16AL.4PP40.12B	11 426	16AL.5PP40.12B	13 402
1360	1300	16AL.3PP40.13B	9 879	16AL.4PP40.13B	11 998	16AL.5PP40.13B	14 117
1460	1400	16AL.3PP40.14B	10 308	16AL.4PP40.14B	12 570	16AL.5PP40.14B	14 831
1560	1500	16AL.3PP40.15B	10 737	16AL.4PP40.15B	13 141	16AL.5PP40.15B	15 546
1660	1600	16AL.3PP40.16B	11 166	16AL.4PP40.16B	13 713	16AL.5PP40.16B	16 260
1760	1700	16AL.3PP40.17B	11 594	16AL.4PP40.17B	14 285	16AL.5PP40.17B	16 975
1860	1800	16AL.3PP40.18B	12 023	16AL.4PP40.18B	14 856	16AL.5PP40.18B	17 690
Дополнительная линейная секция Additional line section / Elemento lineare aggiuntivo							
630	600	16AL.3PP40.06E	4 843	16AL.4PP40.06E	5 963	16AL.5PP40.06E	7 078
730	700	16AL.3PP40.07E	5 272	16AL.4PP40.07E	6 535	16AL.5PP40.07E	7 793
830	800	16AL.3PP40.08E	5 701	16AL.4PP40.08E	7 106	16AL.5PP40.08E	8 507
930	900	16AL.3PP40.09E	6 130	16AL.4PP40.09E	7 677	16AL.5PP40.09E	9 222
1030	1000	16AL.3PP40.10E	6 558	16AL.4PP40.10E	8 248	16AL.5PP40.10E	9 936
1130	1100	16AL.3PP40.11E	6 987	16AL.4PP40.11E	8 820	16AL.5PP40.11E	10 651
1230	1200	16AL.3PP40.12E	7 416	16AL.4PP40.12E	9 392	16AL.5PP40.12E	11 365
1330	1300	16AL.3PP40.13E	7 845	16AL.4PP40.13E	9 963	16AL.5PP40.13E	12 080
1430	1400	16AL.3PP40.14E	8 273	16AL.4PP40.14E	10 535	16AL.5PP40.14E	12 795
1530	1500	16AL.3PP40.15E	8 702	16AL.4PP40.15E	11 107	16AL.5PP40.15E	13 509
1630	1600	16AL.3PP40.16E	9 131	16AL.4PP40.16E	11 678	16AL.5PP40.16E	14 224
1730	1700	16AL.3PP40.17E	9 560	16AL.4PP40.17E	12 250	16AL.5PP40.17E	14 938
1830	1800	16AL.3PP40.18E	9 988	16AL.4PP40.18E	12 822	16AL.5PP40.18E	15 653
Угловая секция Corner section / Elemento angolare							
630	600	16AL.3PP40.06C	4 843	16AL.4PP40.06C	5 963	16AL.5PP40.06C	7 078
730	700	16AL.3PP40.07C	5 272	16AL.4PP40.07C	6 535	16AL.5PP40.07C	7 793
830	800	16AL.3PP40.08C	5 701	16AL.4PP40.08C	7 106	16AL.5PP40.08C	8 507
930	900	16AL.3PP40.09C	6 130	16AL.4PP40.09C	7 677	16AL.5PP40.09C	9 222
1030	1000	16AL.3PP40.10C	6 558	16AL.4PP40.10C	8 248	16AL.5PP40.10C	9 936
1130	1100	16AL.3PP40.11C	6 987	16AL.4PP40.11C	8 820	16AL.5PP40.11C	10 651
1230	1200	16AL.3PP40.12C	7 416	16AL.4PP40.12C	9 392	16AL.5PP40.12C	11 365
1330	1300	16AL.3PP40.13C	7 845	16AL.4PP40.13C	9 963	16AL.5PP40.13C	12 080
1430	1400	16AL.3PP40.14C	8 273	16AL.4PP40.14C	10 535	16AL.5PP40.14C	12 795
1530	1500	16AL.3PP40.15C	8 702	16AL.4PP40.15C	11 107	16AL.5PP40.15C	13 509
1630	1600	16AL.3PP40.16C	9 131	16AL.4PP40.16C	11 678	16AL.5PP40.16C	14 224
1730	1700	16AL.3PP40.17C	9 560	16AL.4PP40.17C	12 250	16AL.5PP40.17C	14 938
1830	1800	16AL.3PP40.18C	9 988	16AL.4PP40.18C	12 822	16AL.5PP40.18C	15 653

H. 1600
D. 500

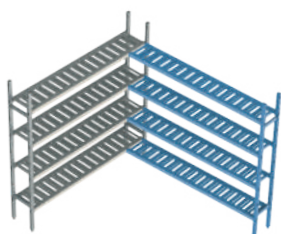
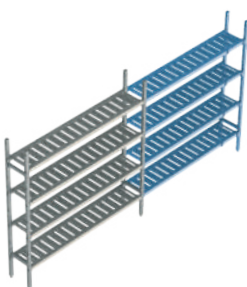
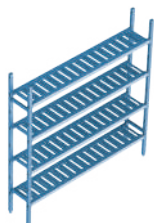

Общая длина, мм Total length, mm Lunghezza totale, mm	Длина полки, мм Shelf length, mm Lunghezza ripiano, mm	Цена, руб. / Price, rubles / Prezzo, rubli					
		3 яруса / 3 tiers / 3 livelli		4 яруса / 4 tiers / 4 livelli		5 ярусов / 5 tiers / 5 livelli	
Базовая секция Basic section / Elemento base							
660	600	16AL.3PP50.06B	7 333	16AL.4PP50.06B	8 545	16AL.5PP50.06B	9 757
760	700	16AL.3PP50.07B	7 808	16AL.4PP50.07B	9 179	16AL.5PP50.07B	10 550
860	800	16AL.3PP50.08B	8 284	16AL.4PP50.08B	9 814	16AL.5PP50.08B	11 343
960	900	16AL.3PP50.09B	8 760	16AL.4PP50.09B	10 448	16AL.5PP50.09B	12 136
1060	1000	16AL.3PP50.10B	9 236	16AL.4PP50.10B	11 082	16AL.5PP50.10B	12 929
1160	1100	16AL.3PP50.11B	9 711	16AL.4PP50.11B	11 717	16AL.5PP50.11B	13 722
1260	1200	16AL.3PP50.12B	10 187	16AL.4PP50.12B	12 351	16AL.5PP50.12B	14 515
1360	1300	16AL.3PP50.13B	10 663	16AL.4PP50.13B	12 986	16AL.5PP50.13B	15 308
1460	1400	16AL.3PP50.14B	11 139	16AL.4PP50.14B	13 620	16AL.5PP50.14B	16 101
1560	1500	16AL.3PP50.15B	11 615	16AL.4PP50.15B	14 254	16AL.5PP50.15B	16 894
1660	1600	16AL.3PP50.16B	12 090	16AL.4PP50.16B	14 889	16AL.5PP50.16B	17 687
1760	1700	16AL.3PP50.17B	12 566	16AL.4PP50.17B	15 523	16AL.5PP50.17B	18 480
1860	1800	16AL.3PP50.18B	13 042	16AL.4PP50.18B	16 158	16AL.5PP50.18B	19 273
Дополнительная линейная секция Additional line section / Elemento lineare aggiuntivo							
630	600	16AL.3PP50.06E	5 213	16AL.4PP50.06E	6 425	16AL.5PP50.06E	7 638
730	700	16AL.3PP50.07E	5 689	16AL.4PP50.07E	7 060	16AL.5PP50.07E	8 431
830	800	16AL.3PP50.08E	6 165	16AL.4PP50.08E	7 694	16AL.5PP50.08E	9 224
930	900	16AL.3PP50.09E	6 640	16AL.4PP50.09E	8 329	16AL.5PP50.09E	10 017
1030	1000	16AL.3PP50.10E	7 116	16AL.4PP50.10E	8 963	16AL.5PP50.10E	10 810
1130	1100	16AL.3PP50.11E	7 592	16AL.4PP50.11E	9 597	16AL.5PP50.11E	11 603
1230	1200	16AL.3PP50.12E	8 068	16AL.4PP50.12E	10 232	16AL.5PP50.12E	12 396
1330	1300	16AL.3PP50.13E	8 544	16AL.4PP50.13E	10 866	16AL.5PP50.13E	13 189
1430	1400	16AL.3PP50.14E	9 019	16AL.4PP50.14E	11 501	16AL.5PP50.14E	13 982
1530	1500	16AL.3PP50.15E	9 495	16AL.4PP50.15E	12 135	16AL.5PP50.15E	14 775
1630	1600	16AL.3PP50.16E	9 971	16AL.4PP50.16E	12 769	16AL.5PP50.16E	15 568
1730	1700	16AL.3PP50.17E	10 447	16AL.4PP50.17E	13 404	16AL.5PP50.17E	16 361
1830	1800	16AL.3PP50.18E	10 923	16AL.4PP50.18E	14 038	16AL.5PP50.18E	17 154
Угловая секция Corner section / Elemento angolare							
630	600	16AL.3PP50.06C	5 213	16AL.4PP50.06C	6 425	16AL.5PP50.06C	7 638
730	700	16AL.3PP50.07C	5 689	16AL.4PP50.07C	7 060	16AL.5PP50.07C	8 431
830	800	16AL.3PP50.08C	6 165	16AL.4PP50.08C	7 694	16AL.5PP50.08C	9 224
930	900	16AL.3PP50.09C	6 640	16AL.4PP50.09C	8 329	16AL.5PP50.09C	10 017
1030	1000	16AL.3PP50.10C	7 116	16AL.4PP50.10C	8 963	16AL.5PP50.10C	10 810
1130	1100	16AL.3PP50.11C	7 592	16AL.4PP50.11C	9 597	16AL.5PP50.11C	11 603
1230	1200	16AL.3PP50.12C	8 068	16AL.4PP50.12C	10 232	16AL.5PP50.12C	12 396
1330	1300	16AL.3PP50.13C	8 544	16AL.4PP50.13C	10 866	16AL.5PP50.13C	13 189
1430	1400	16AL.3PP50.14C	9 019	16AL.4PP50.14C	11 501	16AL.5PP50.14C	13 982
1530	1500	16AL.3PP50.15C	9 495	16AL.4PP50.15C	12 135	16AL.5PP50.15C	14 775
1630	1600	16AL.3PP50.16C	9 971	16AL.4PP50.16C	12 769	16AL.5PP50.16C	15 568
1730	1700	16AL.3PP50.17C	10 447	16AL.4PP50.17C	13 404	16AL.5PP50.17C	16 361
1830	1800	16AL.3PP50.18C	10 923	16AL.4PP50.18C	14 038	16AL.5PP50.18C	17 154

H. 1800
D. 300

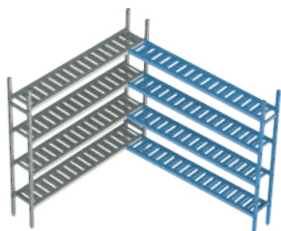
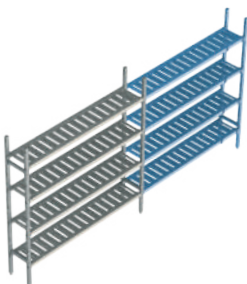
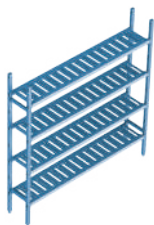

Общая длина, мм Total length, mm Lunghezza totale, mm	Длина полки, мм Shelf length, mm Lunghezza ripiano, mm	Цена, руб. / Price, rubles / Prezzo, rubli					
		3 яруса / 3 tiers / 3 livelli		4 яруса / 4 tiers / 4 livelli		5 ярусов / 5 tiers / 5 livelli	
Базовая секция Basic section / Elemento base							
660	600	18AL.3PP30.06B	7 247	18AL.4PP30.06B	8 361	18AL.5PP30.06B	9 475
760	700	18AL.3PP30.07B	7 674	18AL.4PP30.07B	8 930	18AL.5PP30.07B	10 185
860	800	18AL.3PP30.08B	8 100	18AL.4PP30.08B	9 498	18AL.5PP30.08B	10 896
960	900	18AL.3PP30.09B	8 527	18AL.4PP30.09B	10 067	18AL.5PP30.09B	11 607
1060	1000	18AL.3PP30.10B	8 953	18AL.4PP30.10B	10 635	18AL.5PP30.10B	12 318
1160	1100	18AL.3PP30.11B	9 380	18AL.4PP30.11B	11 204	18AL.5PP30.11B	13 028
1260	1200	18AL.3PP30.12B	9 806	18AL.4PP30.12B	11 772	18AL.5PP30.12B	13 739
1360	1300	18AL.3PP30.13B	10 232	18AL.4PP30.13B	12 341	18AL.5PP30.13B	14 450
1460	1400	18AL.3PP30.14B	10 659	18AL.4PP30.14B	12 910	18AL.5PP30.14B	15 160
1560	1500	18AL.3PP30.15B	11 085	18AL.4PP30.15B	13 478	18AL.5PP30.15B	15 871
1660	1600	18AL.3PP30.16B	11 512	18AL.4PP30.16B	14 047	18AL.5PP30.16B	16 582
1760	1700	18AL.3PP30.17B	11 938	18AL.4PP30.17B	14 615	18AL.5PP30.17B	17 292
1860	1800	18AL.3PP30.18B	12 364	18AL.4PP30.18B	15 184	18AL.5PP30.18B	18 003
Дополнительная линейная секция Additional line section / Elemento lineare aggiuntivo							
630	600	18AL.3PP30.06E	5 303	18AL.4PP30.06E	6 417	18AL.5PP30.06E	7 531
730	700	18AL.3PP30.07E	5 729	18AL.4PP30.07E	6 986	18AL.5PP30.07E	8 243
830	800	18AL.3PP30.08E	6 156	18AL.4PP30.08E	7 555	18AL.5PP30.08E	8 954
930	900	18AL.3PP30.09E	6 583	18AL.4PP30.09E	8 124	18AL.5PP30.09E	9 665
1030	1000	18AL.3PP30.10E	7 010	18AL.4PP30.10E	8 693	18AL.5PP30.10E	10 377
1130	1100	18AL.3PP30.11E	7 437	18AL.4PP30.11E	9 262	18AL.5PP30.11E	11 088
1230	1200	18AL.3PP30.12E	7 863	18AL.4PP30.12E	9 831	18AL.5PP30.12E	11 799
1330	1300	18AL.3PP30.13E	8 290	18AL.4PP30.13E	10 400	18AL.5PP30.13E	12 510
1430	1400	18AL.3PP30.14E	8 717	18AL.4PP30.14E	10 970	18AL.5PP30.14E	13 221
1530	1500	18AL.3PP30.15E	9 144	18AL.4PP30.15E	11 539	18AL.5PP30.15E	13 932
1630	1600	18AL.3PP30.16E	9 571	18AL.4PP30.16E	12 108	18AL.5PP30.16E	14 644
1730	1700	18AL.3PP30.17E	9 997	18AL.4PP30.17E	12 677	18AL.5PP30.17E	15 355
1830	1800	18AL.3PP30.18E	10 424	18AL.4PP30.18E	13 246	18AL.5PP30.18E	16 066
Угловая секция Corner section / Elemento angolare							
630	600	18AL.3PP30.06C	5 303	18AL.4PP30.06C	6 417	18AL.5PP30.06C	7 531
730	700	18AL.3PP30.07C	5 729	18AL.4PP30.07C	6 986	18AL.5PP30.07C	8 243
830	800	18AL.3PP30.08C	6 156	18AL.4PP30.08C	7 555	18AL.5PP30.08C	8 954
930	900	18AL.3PP30.09C	6 583	18AL.4PP30.09C	8 124	18AL.5PP30.09C	9 665
1030	1000	18AL.3PP30.10C	7 010	18AL.4PP30.10C	8 693	18AL.5PP30.10C	10 377
1130	1100	18AL.3PP30.11C	7 437	18AL.4PP30.11C	9 262	18AL.5PP30.11C	11 088
1230	1200	18AL.3PP30.12C	7 863	18AL.4PP30.12C	9 831	18AL.5PP30.12C	11 799
1330	1300	18AL.3PP30.13C	8 290	18AL.4PP30.13C	10 400	18AL.5PP30.13C	12 510
1430	1400	18AL.3PP30.14C	8 717	18AL.4PP30.14C	10 970	18AL.5PP30.14C	13 221
1530	1500	18AL.3PP30.15C	9 144	18AL.4PP30.15C	11 539	18AL.5PP30.15C	13 932
1630	1600	18AL.3PP30.16C	9 571	18AL.4PP30.16C	12 108	18AL.5PP30.16C	14 644
1730	1700	18AL.3PP30.17C	9 997	18AL.4PP30.17C	12 677	18AL.5PP30.17C	15 355
1830	1800	18AL.3PP30.18C	10 424	18AL.4PP30.18C	13 246	18AL.5PP30.18C	16 066

H. 1800
D. 400

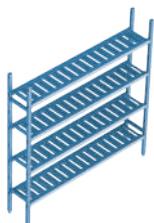

Общая длина, мм Total length, mm Lunghezza totale, mm	Длина полки, мм Shelf length, mm Lunghezza ripiano, mm	Цена, руб. / Price, rubles / Prezzo, rubli					
		3 яруса / 3 tiers / 3 livelli		4 яруса / 4 tiers / 4 livelli		5 ярусов / 5 tiers / 5 livelli	
Базовая секция Basic section / Elemento base							
660	600	18AL.3PP40.06B	7 434	18AL.4PP40.06B	8 552	18AL.5PP40.06B	9 670
760	700	18AL.3PP40.07B	7 862	18AL.4PP40.07B	9 124	18AL.5PP40.07B	10 385
860	800	18AL.3PP40.08B	8 291	18AL.4PP40.08B	9 695	18AL.5PP40.08B	11 099
960	900	18AL.3PP40.09B	8 720	18AL.4PP40.09B	10 267	18AL.5PP40.09B	11 814
1060	1000	18AL.3PP40.10B	9 149	18AL.4PP40.10B	10 839	18AL.5PP40.10B	12 529
1160	1100	18AL.3PP40.11B	9 577	18AL.4PP40.11B	11 410	18AL.5PP40.11B	13 243
1260	1200	18AL.3PP40.12B	10 006	18AL.4PP40.12B	11 982	18AL.5PP40.12B	13 958
1360	1300	18AL.3PP40.13B	10 435	18AL.4PP40.13B	12 554	18AL.5PP40.13B	14 672
1460	1400	18AL.3PP40.14B	10 864	18AL.4PP40.14B	13 125	18AL.5PP40.14B	15 387
1560	1500	18AL.3PP40.15B	11 292	18AL.4PP40.15B	13 697	18AL.5PP40.15B	16 102
1660	1600	18AL.3PP40.16B	11 721	18AL.4PP40.16B	14 269	18AL.5PP40.16B	16 816
1760	1700	18AL.3PP40.17B	12 150	18AL.4PP40.17B	14 840	18AL.5PP40.17B	17 531
1860	1800	18AL.3PP40.18B	12 579	18AL.4PP40.18B	15 412	18AL.5PP40.18B	18 245

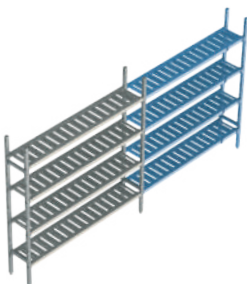

Дополнительная линейная секция Additional line section / Elemento lineare aggiuntivo							
630	600	18AL.3PP40.06E	5 399	18AL.4PP40.06E	6 519	18AL.5PP40.06E	7 634
730	700	18AL.3PP40.07E	5 828	18AL.4PP40.07E	7 090	18AL.5PP40.07E	8 348
830	800	18AL.3PP40.08E	6 256	18AL.4PP40.08E	7 662	18AL.5PP40.08E	9 063
930	900	18AL.3PP40.09E	6 685	18AL.4PP40.09E	8 232	18AL.5PP40.09E	9 777
1030	1000	18AL.3PP40.10E	7 114	18AL.4PP40.10E	8 804	18AL.5PP40.10E	10 492
1130	1100	18AL.3PP40.11E	7 543	18AL.4PP40.11E	9 376	18AL.5PP40.11E	11 207
1230	1200	18AL.3PP40.12E	7 971	18AL.4PP40.12E	9 947	18AL.5PP40.12E	11 921
1330	1300	18AL.3PP40.13E	8 400	18AL.4PP40.13E	10 519	18AL.5PP40.13E	12 636
1430	1400	18AL.3PP40.14E	8 829	18AL.4PP40.14E	11 091	18AL.5PP40.14E	13 350
1530	1500	18AL.3PP40.15E	9 258	18AL.4PP40.15E	11 662	18AL.5PP40.15E	14 065
1630	1600	18AL.3PP40.16E	9 686	18AL.4PP40.16E	12 234	18AL.5PP40.16E	14 779
1730	1700	18AL.3PP40.17E	10 115	18AL.4PP40.17E	12 806	18AL.5PP40.17E	15 494
1830	1800	18AL.3PP40.18E	10 544	18AL.4PP40.18E	13 377	18AL.5PP40.18E	16 209

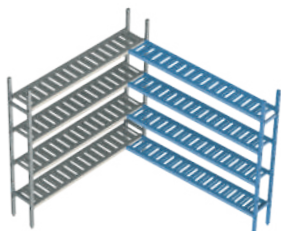

Угловая секция Corner section / Elemento angolare							
630	600	18AL.3PP40.06C	5 399	18AL.4PP40.06C	6 519	18AL.5PP40.06C	7 634
730	700	18AL.3PP40.07C	5 828	18AL.4PP40.07C	7 090	18AL.5PP40.07C	8 348
830	800	18AL.3PP40.08C	6 256	18AL.4PP40.08C	7 662	18AL.5PP40.08C	9 063
930	900	18AL.3PP40.09C	6 685	18AL.4PP40.09C	8 232	18AL.5PP40.09C	9 777
1030	1000	18AL.3PP40.10C	7 114	18AL.4PP40.10C	8 804	18AL.5PP40.10C	10 492
1130	1100	18AL.3PP40.11C	7 543	18AL.4PP40.11C	9 376	18AL.5PP40.11C	11 207
1230	1200	18AL.3PP40.12C	7 971	18AL.4PP40.12C	9 947	18AL.5PP40.12C	11 921
1330	1300	18AL.3PP40.13C	8 400	18AL.4PP40.13C	10 519	18AL.5PP40.13C	12 636
1430	1400	18AL.3PP40.14C	8 829	18AL.4PP40.14C	11 091	18AL.5PP40.14C	13 350
1530	1500	18AL.3PP40.15C	9 258	18AL.4PP40.15C	11 662	18AL.5PP40.15C	14 065
1630	1600	18AL.3PP40.16C	9 686	18AL.4PP40.16C	12 234	18AL.5PP40.16C	14 779
1730	1700	18AL.3PP40.17C	10 115	18AL.4PP40.17C	12 806	18AL.5PP40.17C	15 494
1830	1800	18AL.3PP40.18C	10 544	18AL.4PP40.18C	13 377	18AL.5PP40.18C	16 209

H. 1800
D. 500

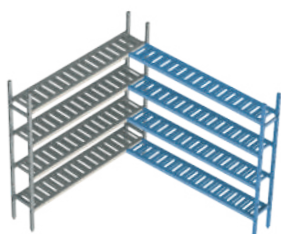
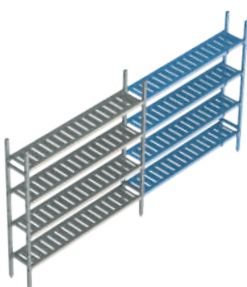
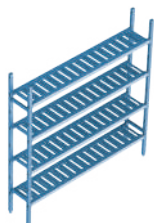

Общая длина, мм Total length, mm Lunghezza totale, mm	Длина полки, мм Shelf length, mm Lunghezza ripiano, mm	Цена, руб. / Price, rubles / Prezzo, rubli					
		3 яруса / 3 tiers / 3 livelli		4 яруса / 4 tiers / 4 livelli		5 ярусов / 5 tiers / 5 livelli	
Базовая секция Basic section / Elemento base							
660	600	18AL.3PP50.06B	7 888	18AL.4PP50.06B	9 101	18AL.5PP50.06B	10 313
760	700	18AL.3PP50.07B	8 364	18AL.4PP50.07B	9 735	18AL.5PP50.07B	11 106
860	800	18AL.3PP50.08B	8 840	18AL.4PP50.08B	10 369	18AL.5PP50.08B	11 899
960	900	18AL.3PP50.09B	9 316	18AL.4PP50.09B	11 004	18AL.5PP50.09B	12 692
1060	1000	18AL.3PP50.10B	9 791	18AL.4PP50.10B	11 638	18AL.5PP50.10B	13 485
1160	1100	18AL.3PP50.11B	10 267	18AL.4PP50.11B	12 273	18AL.5PP50.11B	14 278
1260	1200	18AL.3PP50.12B	10 743	18AL.4PP50.12B	12 907	18AL.5PP50.12B	15 071
1360	1300	18AL.3PP50.13B	11 219	18AL.4PP50.13B	13 541	18AL.5PP50.13B	15 864
1460	1400	18AL.3PP50.14B	11 695	18AL.4PP50.14B	14 176	18AL.5PP50.14B	16 657
1560	1500	18AL.3PP50.15B	12 170	18AL.4PP50.15B	14 810	18AL.5PP50.15B	17 450
1660	1600	18AL.3PP50.16B	12 646	18AL.4PP50.16B	15 444	18AL.5PP50.16B	18 243
1760	1700	18AL.3PP50.17B	13 122	18AL.4PP50.17B	16 079	18AL.5PP50.17B	19 036
1860	1800	18AL.3PP50.18B	13 598	18AL.4PP530.18B	16 713	18AL.5PP50.18B	19 829
Дополнительная линейная секция Additional line section / Elemento lineare aggiuntivo							
630	600	18AL.3PP50.06E	5 769	18AL.4PP50.06E	6 981	18AL.5PP50.06E	8 193
730	700	18AL.3PP50.07E	6 244	18AL.4PP50.07E	7 615	18AL.5PP50.07E	8 986
830	800	18AL.3PP50.08E	6 720	18AL.4PP50.08E	8 250	18AL.5PP50.08E	9 779
930	900	18AL.3PP50.09E	7 196	18AL.4PP50.09E	8 884	18AL.5PP50.09E	10 572
1030	1000	18AL.3PP50.10E	7 672	18AL.4PP50.10E	9 519	18AL.5PP50.10E	11 365
1130	1100	18AL.3PP50.11E	8 148	18AL.4PP50.11E	10 153	18AL.5PP50.11E	12 158
1230	1200	18AL.3PP50.12E	8 623	18AL.4PP50.12E	10 787	18AL.5PP50.12E	12 951
1330	1300	18AL.3PP50.13E	9 099	18AL.4PP50.13E	11 422	18AL.5PP50.13E	13 744
1430	1400	18AL.3PP50.14E	9 575	18AL.4PP50.14E	12 056	18AL.5PP50.14E	14 537
1530	1500	18AL.3PP50.15E	10 051	18AL.4PP50.15E	12 691	18AL.5PP50.15E	15 330
1630	1600	18AL.3PP50.16E	10 527	18AL.4PP50.16E	13 325	18AL.5PP50.16E	16 123
1730	1700	18AL.3PP50.17E	11 002	18AL.4PP50.17E	13 959	18AL.5PP50.17E	16 916
1830	1800	18AL.3PP50.18E	11 478	18AL.4PP50.18E	14 594	18AL.5PP50.18E	17 709
Угловая секция Corner section / Elemento angolare							
630	600	18AL.3PP50.06C	5 769	18AL.4PP50.06C	6 981	18AL.5PP50.06C	8 193
730	700	18AL.3PP50.07C	6 244	18AL.4PP50.07C	7 615	18AL.5PP50.07C	8 986
830	800	18AL.3PP50.08C	6 720	18AL.4PP50.08C	8 250	18AL.5PP50.08C	9 779
930	900	18AL.3PP50.09C	7 196	18AL.4PP50.09C	8 884	18AL.5PP50.09C	10 572
1030	1000	18AL.3PP50.10C	7 672	18AL.4PP50.10C	9 519	18AL.5PP50.10C	11 365
1130	1100	18AL.3PP50.11C	8 148	18AL.4PP50.11C	10 153	18AL.5PP50.11C	12 158
1230	1200	18AL.3PP50.12C	8 623	18AL.4PP50.12C	10 787	18AL.5PP50.12C	12 951
1330	1300	18AL.3PP50.13C	9 099	18AL.4PP50.13C	11 422	18AL.5PP50.13C	13 744
1430	1400	18AL.3PP50.14C	9 575	18AL.4PP50.14C	12 056	18AL.5PP50.14C	14 537
1530	1500	18AL.3PP50.15C	10 051	18AL.4PP50.15C	12 691	18AL.5PP50.15C	15 330
1630	1600	18AL.3PP50.16C	10 527	18AL.4PP50.16C	13 325	18AL.5PP50.16C	16 123
1730	1700	18AL.3PP50.17C	11 002	18AL.4PP50.17C	13 959	18AL.5PP50.17C	16 916
1830	1800	18AL.3PP50.18C	11 478	18AL.4PP50.18C	14 594	18AL.5PP50.18C	17 709

H. 2100
D. 300

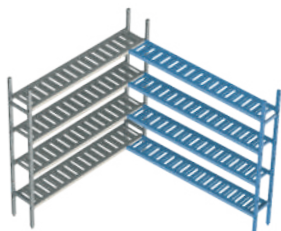
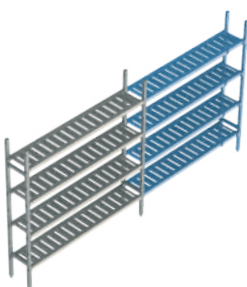
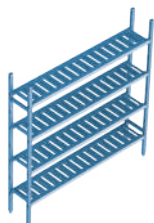

Общая длина, мм Total length, mm Lunghezza totale, mm	Длина полки, мм Shelf length, mm Lunghezza ripiano, mm	Цена, руб. / Price, rubles / Prezzo, rubli					
		3 яруса / 3 tiers / 3 livelli		4 яруса / 4 tiers / 4 livelli		5 ярусов / 5 tiers / 5 livelli	
Базовая секция Basic section / Elemento base							
660	600	21AL.3PP30.06B	7 803	21AL.4PP30.06B	8 917	21AL.5PP30.06B	10 030
760	700	21AL.3PP30.07B	8 230	21AL.4PP30.07B	9 485	21AL.5PP30.07B	10 741
860	800	21AL.3PP30.08B	8 656	21AL.4PP30.08B	10 054	21AL.5PP30.08B	11 452
960	900	21AL.3PP30.09B	9 082	21AL.4PP30.09B	10 622	21AL.5PP30.09B	12 163
1060	1000	21AL.3PP30.10B	9 509	21AL.4PP30.10B	11 191	21AL.5PP30.10B	12 873
1160	1100	21AL.3PP30.11B	9 935	21AL.4PP30.11B	11 760	21AL.5PP30.11B	13 584
1260	1200	21AL.3PP30.12B	10 362	21AL.4PP30.12B	12 328	21AL.5PP30.12B	14 295
1360	1300	21AL.3PP30.13B	10 788	21AL.4PP30.13B	12 897	21AL.5PP30.13B	15 005
1460	1400	21AL.3PP30.14B	11 214	21AL.4PP30.14B	13 465	21AL.5PP30.14B	15 716
1560	1500	21AL.3PP30.15B	11 641	21AL.4PP30.15B	14 034	21AL.5PP30.15B	16 427
1660	1600	21AL.3PP30.16B	12 067	21AL.4PP30.16B	14 602	21AL.5PP30.16B	17 137
1760	1700	21AL.3PP30.17B	12 494	21AL.4PP30.17B	15 171	21AL.5PP30.17B	17 848
1860	1800	21AL.3PP30.18B	12 920	21AL.4PP30.18B	15 739	21AL.5PP30.18B	18 559
Дополнительная линейная секция Additional line section / Elemento lineare aggiuntivo							
630	600	21AL.3PP30.06E	5 858	21AL.4PP30.06E	6 973	21AL.5PP30.06E	8 087
730	700	21AL.3PP30.07E	6 285	21AL.4PP30.07E	7 542	21AL.5PP30.07E	8 798
830	800	21AL.3PP30.08E	6 712	21AL.4PP30.08E	8 111	21AL.5PP30.08E	9 510
930	900	21AL.3PP30.09E	7 139	21AL.4PP30.09E	8 680	21AL.5PP30.09E	10 221
1030	1000	21AL.3PP30.10E	7 565	21AL.4PP30.10E	9 249	21AL.5PP30.10E	10 932
1130	1100	21AL.3PP30.11E	7 992	21AL.4PP30.11E	9 818	21AL.5PP30.11E	11 643
1230	1200	21AL.3PP30.12E	8 419	21AL.4PP30.12E	10 387	21AL.5PP30.12E	12 355
1330	1300	21AL.3PP30.13E	8 846	21AL.4PP30.13E	10 956	21AL.5PP30.13E	13 066
1430	1400	21AL.3PP30.14E	9 273	21AL.4PP30.14E	11 525	21AL.5PP30.14E	13 777
1530	1500	21AL.3PP30.15E	9 699	21AL.4PP30.15E	12 094	21AL.5PP30.15E	14 488
1630	1600	21AL.3PP30.16E	10 126	21AL.4PP30.16E	12 663	21AL.5PP30.16E	15 199
1730	1700	21AL.3PP30.17E	10 553	21AL.4PP30.17E	13 232	21AL.5PP30.17E	15 911
1830	1800	21AL.3PP30.18E	10 980	21AL.4PP30.18E	13 801	21AL.5PP30.18E	16 622
Угловая секция Corner section / Elemento angolare							
630	600	21AL.3PP30.06C	5 858	21AL.4PP30.06C	6 973	21AL.5PP30.06C	8 087
730	700	21AL.3PP30.07C	6 285	21AL.4PP30.07C	7 542	21AL.5PP30.07C	8 798
830	800	21AL.3PP30.08C	6 712	21AL.4PP30.08C	8 111	21AL.5PP30.08C	9 510
930	900	21AL.3PP30.09C	7 139	21AL.4PP30.09C	8 680	21AL.5PP30.09C	10 221
1030	1000	21AL.3PP30.10C	7 565	21AL.4PP30.10C	9 249	21AL.5PP30.10C	10 932
1130	1100	21AL.3PP30.11C	7 992	21AL.4PP30.11C	9 818	21AL.5PP30.11C	11 643
1230	1200	21AL.3PP30.12C	8 419	21AL.4PP30.12C	10 387	21AL.5PP30.12C	12 355
1330	1300	21AL.3PP30.13C	8 846	21AL.4PP30.13C	10 956	21AL.5PP30.13C	13 066
1430	1400	21AL.3PP30.14C	9 273	21AL.4PP30.14C	11 525	21AL.5PP30.14C	13 777
1530	1500	21AL.3PP30.15C	9 699	21AL.4PP30.15C	12 094	21AL.5PP30.15C	14 488
1630	1600	21AL.3PP30.16C	10 126	21AL.4PP30.16C	12 663	21AL.5PP30.16C	15 199
1730	1700	21AL.3PP30.17C	10 553	21AL.4PP30.17C	13 232	21AL.5PP30.17C	15 911
1830	1800	21AL.3PP30.18C	10 980	21AL.4PP30.18C	13 801	21AL.5PP30.18C	16 622

H. 2100
D. 400

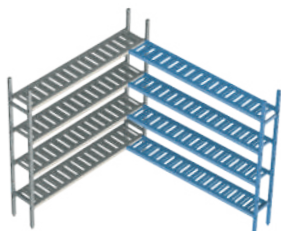
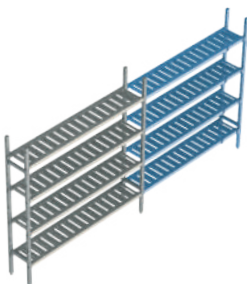
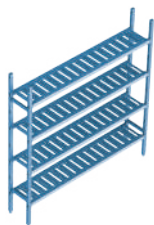

Общая длина, мм Total length, mm Lunghezza totale, mm	Длина полки, мм Shelf length, mm Lunghezza ripiano, mm	Цена, руб. / Price, rubles / Prezzo, rubli					
		3 яруса / 3 tiers / 3 livelli		4 яруса / 4 tiers / 4 livelli		5 ярусов / 5 tiers / 5 livelli	
Базовая секция Basic section / Elemento base							
660	600	21AL.3PP40.06B	7 989	21AL.4PP40.06B	9 108	21AL.5PP40.06B	10 226
760	700	21AL.3PP40.07B	8 418	21AL.4PP40.07B	9 679	21AL.5PP40.07B	10 941
860	800	21AL.3PP40.08B	8 847	21AL.4PP40.08B	10 251	21AL.5PP40.08B	11 655
960	900	21AL.3PP40.09B	9 276	21AL.4PP40.09B	10 823	21AL.5PP40.09B	12 370
1060	1000	21AL.3PP40.10B	9 704	21AL.4PP40.10B	11 394	21AL.5PP40.10B	13 084
1160	1100	21AL.3PP40.11B	10 133	21AL.4PP40.11B	11 966	21AL.5PP40.11B	13 799
1260	1200	21AL.3PP40.12B	10 562	21AL.4PP40.12B	12 538	21AL.5PP40.12B	14 513
1360	1300	21AL.3PP40.13B	10 991	21AL.4PP40.13B	13 109	21AL.5PP40.13B	15 228
1460	1400	21AL.3PP40.14B	11 419	21AL.4PP40.14B	13 681	21AL.5PP40.14B	15 943
1560	1500	21AL.3PP40.15B	11 848	21AL.4PP40.15B	14 253	21AL.5PP40.15B	16 657
1660	1600	21AL.3PP40.16B	12 277	21AL.4PP40.16B	14 824	21AL.5PP40.16B	17 372
1760	1700	21AL.3PP40.17B	12 706	21AL.4PP40.17B	15 396	21AL.5PP40.17B	18 086
1860	1800	21AL.3PP40.18B	13 134	21AL.4PP40.18B	15 968	21AL.5PP40.18B	18 801
Дополнительная линейная секция Additional line section / Elemento lineare aggiuntivo							
630	600	21AL.3PP40.06E	5 955	21AL.4PP40.06E	7 074	21AL.5PP40.06E	8 189
730	700	21AL.3PP40.07E	6 383	21AL.4PP40.07E	7 646	21AL.5PP40.07E	8 904
830	800	21AL.3PP40.08E	6 812	21AL.4PP40.08E	8 218	21AL.5PP40.08E	9 618
930	900	21AL.3PP40.09E	7 241	21AL.4PP40.09E	8 788	21AL.5PP40.09E	10 333
1030	1000	21AL.3PP40.10E	7 670	21AL.4PP40.10E	9 360	21AL.5PP40.10E	11 048
1130	1100	21AL.3PP40.11E	8 098	21AL.4PP40.11E	9 931	21AL.5PP40.11E	11 762
1230	1200	21AL.3PP40.12E	8 527	21AL.4PP40.12E	10 503	21AL.5PP40.12E	12 477
1330	1300	21AL.3PP40.13E	8 956	21AL.4PP40.13E	11 075	21AL.5PP40.13E	13 191
1430	1400	21AL.3PP40.14E	9 385	21AL.4PP40.14E	11 646	21AL.5PP40.14E	13 906
1530	1500	21AL.3PP40.15E	9 813	21AL.4PP40.15E	12 218	21AL.5PP40.15E	14 621
1630	1600	21AL.3PP40.16E	10 242	21AL.4PP40.16E	12 790	21AL.5PP40.16E	15 335
1730	1700	21AL.3PP40.17E	10 671	21AL.4PP40.17E	13 361	21AL.5PP40.17E	16 050
1830	1800	21AL.3PP40.18E	11 100	21AL.4PP40.18E	13 933	21AL.5PP40.18E	16 764
Угловая секция Corner section / Elemento angolare							
630	600	21AL.3PP40.06C	5 955	21AL.4PP40.06C	7 074	21AL.5PP40.06C	8 189
730	700	21AL.3PP40.07C	6 383	21AL.4PP40.07C	7 646	21AL.5PP40.07C	8 904
830	800	21AL.3PP40.08C	6 812	21AL.4PP40.08C	8 218	21AL.5PP40.08C	9 618
930	900	21AL.3PP40.09C	7 241	21AL.4PP40.09C	8 788	21AL.5PP40.09C	10 333
1030	1000	21AL.3PP40.10C	7 670	21AL.4PP40.10C	9 360	21AL.5PP40.10C	11 048
1130	1100	21AL.3PP40.11C	8 098	21AL.4PP40.11C	9 931	21AL.5PP40.11C	11 762
1230	1200	21AL.3PP40.12C	8 527	21AL.4PP40.12C	10 503	21AL.5PP40.12C	12 477
1330	1300	21AL.3PP40.13C	8 956	21AL.4PP40.13C	11 075	21AL.5PP40.13C	13 191
1430	1400	21AL.3PP40.14C	9 385	21AL.4PP40.14C	11 646	21AL.5PP40.14C	13 906
1530	1500	21AL.3PP40.15C	9 813	21AL.4PP40.15C	12 218	21AL.5PP40.15C	14 621
1630	1600	21AL.3PP40.16C	10 242	21AL.4PP40.16C	12 790	21AL.5PP40.16C	15 335
1730	1700	21AL.3PP40.17C	10 671	21AL.4PP40.17C	13 361	21AL.5PP40.17C	16 050
1830	1800	21AL.3PP40.18C	11 100	21AL.4PP40.18C	13 933	21AL.5PP40.18C	16 764

H. 2100
D. 500

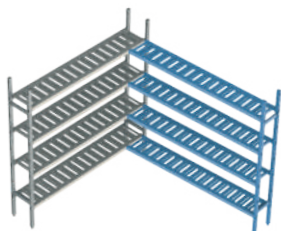
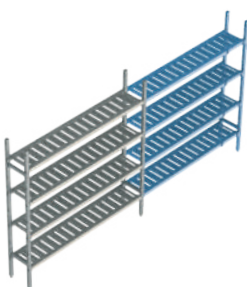
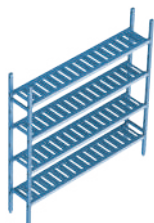

Общая длина, мм Total length, mm Lunghezza totale, mm	Длина полки, мм Shelf length, mm Lunghezza ripiano, mm	Цена, руб. / Price, rubles / Prezzo, rubli					
		3 яруса / 3 tiers / 3 livelli		4 яруса / 4 tiers / 4 livelli		5 ярусов / 5 tiers / 5 livelli	
Базовая секция Basic section / Elemento base							
660	600	21AL.3PP50.06B	8 444	21AL.4PP50.06B	9 656	21AL.5PP50.06B	10 869
760	700	21AL.3PP50.07B	8 920	21AL.4PP50.07B	10 291	21AL.5PP50.07B	11 662
860	800	21AL.3PP50.08B	9 395	21AL.4PP50.08B	10 925	21AL.5PP50.08B	12 455
960	900	21AL.3PP50.09B	9 871	21AL.4PP50.09B	11 559	21AL.5PP50.09B	13 248
1060	1000	21AL.3PP50.10B	10 347	21AL.4PP50.10B	12 194	21AL.5PP50.10B	14 041
1160	1100	21AL.3PP50.11B	10 823	21AL.4PP50.11B	12 828	21AL.5PP50.11B	14 834
1260	1200	21AL.3PP50.12B	11 299	21AL.4PP50.12B	13 463	21AL.5PP50.12B	15 627
1360	1300	21AL.3PP50.13B	11 774	21AL.4PP50.13B	14 097	21AL.5PP50.13B	16 420
1460	1400	21AL.3PP50.14B	12 250	21AL.4PP50.14B	14 731	21AL.5PP50.14B	17 213
1560	1500	21AL.3PP50.15B	12 726	21AL.4PP50.15B	15 366	21AL.5PP50.15B	18 006
1660	1600	21AL.3PP50.16B	13 202	21AL.4PP50.16B	16 000	21AL.5PP50.16B	18 799
1760	1700	21AL.3PP50.17B	13 678	21AL.4PP50.17B	16 635	21AL.5PP50.17B	19 592
1860	1800	21AL.3PP50.18B	14 153	21AL.4PP50.18B	17 269	21AL.5PP50.18B	20 385
Дополнительная линейная секция Additional line section / Elemento lineare aggiuntivo							
630	600	21AL.3PP50.06E	6 324	21AL.4PP50.06E	7 537	21AL.5PP50.06E	8 749
730	700	21AL.3PP50.07E	6 800	21AL.4PP50.07E	8 171	21AL.5PP50.07E	9 542
830	800	21AL.3PP50.08E	7 276	21AL.4PP50.08E	8 806	21AL.5PP50.08E	10 335
930	900	21AL.3PP50.09E	7 752	21AL.4PP50.09E	9 440	21AL.5PP50.09E	11 128
1030	1000	21AL.3PP50.10E	8 227	21AL.4PP50.10E	10 074	21AL.5PP50.10E	11 921
1130	1100	21AL.3PP50.11E	8 703	21AL.4PP50.11E	10 709	21AL.5PP50.11E	12 714
1230	1200	21AL.3PP50.12E	9 179	21AL.4PP50.12E	11 343	21AL.5PP50.12E	13 507
1330	1300	21AL.3PP50.13E	9 655	21AL.4PP50.13E	11 977	21AL.5PP50.13E	14 300
1430	1400	21AL.3PP50.14E	10 131	21AL.4PP50.14E	12 612	21AL.5PP50.14E	15 093
1530	1500	21AL.3PP50.15E	10 606	21AL.4PP50.15E	13 246	21AL.5PP50.15E	15 886
1630	1600	21AL.3PP50.16E	11 082	21AL.4PP50.16E	13 881	21AL.5PP50.16E	16 679
1730	1700	21AL.3PP50.17E	11 558	21AL.4PP50.17E	14 515	21AL.5PP50.17E	17 472
1830	1800	21AL.3PP50.18E	12 034	21AL.4PP50.18E	15 149	21AL.5PP50.18E	18 265
Угловая секция Corner section / Elemento angolare							
630	600	21AL.3PP50.06C	6 324	21AL.4PP50.06C	7 537	21AL.5PP50.06C	8 749
730	700	21AL.3PP50.07C	6 800	21AL.4PP50.07C	8 171	21AL.5PP50.07C	9 542
830	800	21AL.3PP50.08C	7 276	21AL.4PP50.08C	8 806	21AL.5PP50.08C	10 335
930	900	21AL.3PP50.09C	7 752	21AL.4PP50.09C	9 440	21AL.5PP50.09C	11 128
1030	1000	21AL.3PP50.10C	8 227	21AL.4PP50.10C	10 074	21AL.5PP50.10C	11 921
1130	1100	21AL.3PP50.11C	8 703	21AL.4PP50.11C	10 709	21AL.5PP50.11C	12 714
1230	1200	21AL.3PP50.12C	9 179	21AL.4PP50.12C	11 343	21AL.5PP50.12C	13 507
1330	1300	21AL.3PP50.13C	9 655	21AL.4PP50.13C	11 977	21AL.5PP50.13C	14 300
1430	1400	21AL.3PP50.14C	10 131	21AL.4PP50.14C	12 612	21AL.5PP50.14C	15 093
1530	1500	21AL.3PP50.15C	10 606	21AL.4PP50.15C	13 246	21AL.5PP50.15C	15 886
1630	1600	21AL.3PP50.16C	11 082	21AL.4PP50.16C	13 881	21AL.5PP50.16C	16 679
1730	1700	21AL.3PP50.17C	11 558	21AL.4PP50.17C	14 515	21AL.5PP50.17C	17 472
1830	1800	21AL.3PP50.18C	12 034	21AL.4PP50.18C	15 149	21AL.5PP50.18C	18 265

H. 1600
D. 300

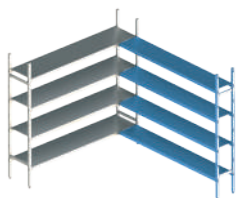
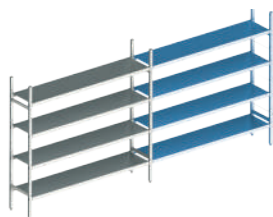

Общая длина, мм Total length, mm Lunghezza totale, mm	Длина полки, мм Shelf length, mm Lunghezza ripiano, mm	Цена, руб. / Price, rubles / Prezzo, rubli					
		3 яруса / 3 tiers / 3 livelli		4 яруса / 4 tiers / 4 livelli		5 ярусов / 5 tiers / 5 livelli	
Базовая секция Basic section / Elemento base							
660	600	16AL.3IN30.06B	8 707	16AL.4IN30.06B	10 386	16AL.5IN30.06B	12 065
760	700	16AL.3IN30.07B	9 313	16AL.4IN30.07B	11 194	16AL.5IN30.07B	13 075
860	800	16AL.3IN30.08B	9 887	16AL.4IN30.08B	11 959	16AL.5IN30.08B	14 031
960	900	16AL.3IN30.09B	10 772	16AL.4IN30.09B	13 140	16AL.5IN30.09B	15 507
1060	1000	16AL.3IN30.10B	11 378	16AL.4IN30.10B	13 947	16AL.5IN30.10B	16 517
1160	1100	16AL.3IN30.11B	11 971	16AL.4IN30.11B	14 738	16AL.5IN30.11B	17 505
1260	1200	16AL.3IN30.12B	12 589	16AL.4IN30.12B	15 562	16AL.5IN30.12B	18 535
1360	1300	16AL.3IN30.13B	13 443	16AL.4IN30.13B	16 701	16AL.5IN30.13B	19 958
1460	1400	16AL.3IN30.14B	14 049	16AL.4IN30.14B	17 508	16AL.5IN30.14B	20 968
1560	1500	16AL.3IN30.15B	14 654	16AL.4IN30.15B	18 316	16AL.5IN30.15B	21 977
1660	1600	16AL.3IN30.16B	15 260	16AL.4IN30.16B	19 123	16AL.5IN30.16B	22 986
1760	1700	16AL.3IN30.17B	16 114	16AL.4IN30.17B	20 262	16AL.5IN30.17B	24 410
1860	1800	16AL.3IN30.18B	16 719	16AL.4IN30.18B	21 069	16AL.5IN30.18B	25 419
Дополнительная линейная секция Additional line section / Elemento lineare aggiuntivo							
630	600	16AL.3IN30.06E	6 872	16AL.4IN30.06E	8 551	16AL.5IN30.06E	10 230
730	700	16AL.3IN30.07E	7 478	16AL.4IN30.07E	9 359	16AL.5IN30.07E	11 240
830	800	16AL.3IN30.08E	8 052	16AL.4IN30.08E	10 124	16AL.5IN30.08E	12 196
930	900	16AL.3IN30.09E	8 937	16AL.4IN30.09E	11 305	16AL.5IN30.09E	13 672
1030	1000	16AL.3IN30.10E	9 543	16AL.4IN30.10E	12 112	16AL.5IN30.10E	14 682
1130	1100	16AL.3IN30.11E	10 136	16AL.4IN30.11E	12 903	16AL.5IN30.11E	15 670
1230	1200	16AL.3IN30.12E	10 754	16AL.4IN30.12E	13 727	16AL.5IN30.12E	16 700
1330	1300	16AL.3IN30.13E	11 608	16AL.4IN30.13E	14 866	16AL.5IN30.13E	18 123
1430	1400	16AL.3IN30.14E	12 214	16AL.4IN30.14E	15 673	16AL.5IN30.14E	19 133
1530	1500	16AL.3IN30.15E	12 819	16AL.4IN30.15E	16 481	16AL.5IN30.15E	20 142
1630	1600	16AL.3IN30.16E	13 425	16AL.4IN30.16E	17 288	16AL.5IN30.16E	21 151
1730	1700	16AL.3IN30.17E	14 279	16AL.4IN30.17E	18 427	16AL.5IN30.17E	22 575
1830	1800	16AL.3IN30.18E	14 884	16AL.4IN30.18E	19 234	16AL.5IN30.18E	23 584
Угловая секция Corner section / Elemento angolare							
630	600	16AL.3IN30.06C	6 872	16AL.4IN30.06C	8 551	16AL.5IN30.06C	10 230
730	700	16AL.3IN30.07C	7 478	16AL.4IN30.07C	9 359	16AL.5IN30.07C	11 240
830	800	16AL.3IN30.08C	8 052	16AL.4IN30.08C	10 124	16AL.5IN30.08C	12 196
930	900	16AL.3IN30.09C	8 937	16AL.4IN30.09C	11 305	16AL.5IN30.09C	13 672
1030	1000	16AL.3IN30.10C	9 543	16AL.4IN30.10C	12 112	16AL.5IN30.10C	14 682
1130	1100	16AL.3IN30.11C	10 136	16AL.4IN30.11C	12 903	16AL.5IN30.11C	15 670
1230	1200	16AL.3IN30.12C	10 754	16AL.4IN30.12C	13 727	16AL.5IN30.12C	16 700
1330	1300	16AL.3IN30.13C	11 608	16AL.4IN30.13C	14 866	16AL.5IN30.13C	18 123
1430	1400	16AL.3IN30.14C	12 214	16AL.4IN30.14C	15 673	16AL.5IN30.14C	19 133
1530	1500	16AL.3IN30.15C	12 819	16AL.4IN30.15C	16 481	16AL.5IN30.15C	20 142
1630	1600	16AL.3IN30.16C	13 425	16AL.4IN30.16C	17 288	16AL.5IN30.16C	21 151
1730	1700	16AL.3IN30.17C	14 279	16AL.4IN30.17C	18 427	16AL.5IN30.17C	22 575
1830	1800	16AL.3IN30.18C	14 884	16AL.4IN30.18C	19 234	16AL.5IN30.18C	23 584

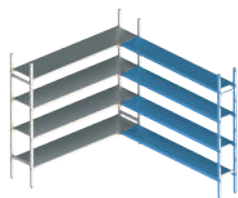
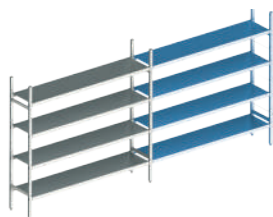
H. 1600
D. 400

Общая длина, мм Total length, mm Lunghezza totale, mm	Длина полки, мм Shelf length, mm Lunghezza ripiano, mm	Цена, руб. / Price, rubles / Prezzo, rubli					
		3 яруса / 3 tiers / 3 livelli		4 яруса / 4 tiers / 4 livelli		5 ярусов / 5 tiers / 5 livelli	
Базовая секция Basic section / Elemento base							
660	600	16AL.3IN40.06B	9 664	16AL.4IN40.06B	11 578	16AL.5IN40.06B	13 492
760	700	16AL.3IN40.07B	10 328	16AL.4IN40.07B	12 464	16AL.5IN40.07B	14 599
860	800	16AL.3IN40.08B	10 993	16AL.4IN40.08B	13 350	16AL.5IN40.08B	15 706
960	900	16AL.3IN40.09B	12 082	16AL.4IN40.09B	14 802	16AL.5IN40.09B	17 522
1060	1000	16AL.3IN40.10B	12 746	16AL.4IN40.10B	15 687	16AL.5IN40.10B	18 629
1160	1100	16AL.3IN40.11B	13 410	16AL.4IN40.11B	16 573	16AL.5IN40.11B	19 736
1260	1200	16AL.3IN40.12B	14 075	16AL.4IN40.12B	17 459	16AL.5IN40.12B	20 843
1360	1300	16AL.3IN40.13B	15 164	16AL.4IN40.13B	18 911	16AL.5IN40.13B	22 658
1460	1400	16AL.3IN40.14B	15 828	16AL.4IN40.14B	19 797	16AL.5IN40.14B	23 765
1560	1500	16AL.3IN40.15B	16 492	16AL.4IN40.15B	20 682	16AL.5IN40.15B	24 872
1660	1600	16AL.3IN40.16B	17 157	16AL.4IN40.16B	21 568	16AL.5IN40.16B	25 980
1760	1700	16AL.3IN40.17B	18 246	16AL.4IN40.17B	23 020	16AL.5IN40.17B	27 795
1860	1800	16AL.3IN40.18B	18 910	16AL.4IN40.18B	23 906	16AL.5IN40.18B	28 902
Дополнительная линейная секция Additional line section / Elemento lineare aggiuntivo							
630	600	16AL.3IN40.06E	7 703	16AL.4IN40.06E	9 617	16AL.5IN40.06E	11 531
730	700	16AL.3IN40.07E	8 367	16AL.4IN40.07E	10 503	16AL.5IN40.07E	12 638
830	800	16AL.3IN40.08E	9 032	16AL.4IN40.08E	11 389	16AL.5IN40.08E	13 745
930	900	16AL.3IN40.09E	10 121	16AL.4IN40.09E	12 841	16AL.5IN40.09E	15 561
1030	1000	16AL.3IN40.10E	10 785	16AL.4IN40.10E	13 726	16AL.5IN40.10E	16 668
1130	1100	16AL.3IN40.11E	11 449	16AL.4IN40.11E	14 612	16AL.5IN40.11E	17 775
1230	1200	16AL.3IN40.12E	12 114	16AL.4IN40.12E	15 498	16AL.5IN40.12E	18 882
1330	1300	16AL.3IN40.13E	13 203	16AL.4IN40.13E	16 950	16AL.5IN40.13E	20 697
1430	1400	16AL.3IN40.14E	13 867	16AL.4IN40.14E	17 836	16AL.5IN40.14E	21 804
1530	1500	16AL.3IN40.15E	14 531	16AL.4IN40.15E	18 721	16AL.5IN40.15E	22 911
1630	1600	16AL.3IN40.16E	15 196	16AL.4IN40.16E	19 607	16AL.5IN40.16E	24 019
1730	1700	16AL.3IN40.17E	16 285	16AL.4IN40.17E	21 059	16AL.5IN40.17E	25 834
1830	1800	16AL.3IN40.18E	16 949	16AL.4IN40.18E	21 945	16AL.5IN40.18E	26 941
Угловая секция Corner section / Elemento angolare							
630	600	16AL.3IN40.06C	7 703	16AL.4IN40.06C	9 617	16AL.5IN40.06C	11 531
730	700	16AL.3IN40.07C	8 367	16AL.4IN40.07C	10 503	16AL.5IN40.07C	12 638
830	800	16AL.3IN40.08C	9 032	16AL.4IN40.08C	11 389	16AL.5IN40.08C	13 745
930	900	16AL.3IN40.09C	10 121	16AL.4IN40.09C	12 841	16AL.5IN40.09C	15 561
1030	1000	16AL.3IN40.10C	10 785	16AL.4IN40.10C	13 726	16AL.5IN40.10C	16 668
1130	1100	16AL.3IN40.11C	11 449	16AL.4IN40.11C	14 612	16AL.5IN40.11C	17 775
1230	1200	16AL.3IN40.12C	12 114	16AL.4IN40.12C	15 498	16AL.5IN40.12C	18 882
1330	1300	16AL.3IN40.13C	13 203	16AL.4IN40.13C	16 950	16AL.5IN40.13C	20 697
1430	1400	16AL.3IN40.14C	13 867	16AL.4IN40.14C	17 836	16AL.5IN40.14C	21 804
1530	1500	16AL.3IN40.15C	14 531	16AL.4IN40.15C	18 721	16AL.5IN40.15C	22 911
1630	1600	16AL.3IN40.16C	15 196	16AL.4IN40.16C	19 607	16AL.5IN40.16C	24 019
1730	1700	16AL.3IN40.17C	16 285	16AL.4IN40.17C	21 059	16AL.5IN40.17C	25 834
1830	1800	16AL.3IN40.18C	16 949	16AL.4IN40.18C	21 945	16AL.5IN40.18C	26 941

H. 1600
D. 500

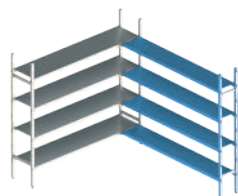
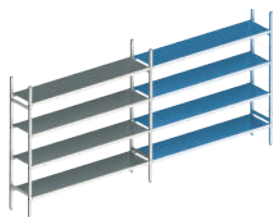

Общая длина, мм Total length, mm Lunghezza totale, mm	Длина полки, мм Shelf length, mm Lunghezza ripiano, mm	Цена, руб. / Price, rubles / Prezzo, rubli					
		3 яруса / 3 tiers / 3 livelli		4 яруса / 4 tiers / 4 livelli		5 ярусов / 5 tiers / 5 livelli	
Базовая секция Basic section / Elemento base							
660	600	16AL.3IN50.06B	10 638	16AL.4IN50.06B	12 793	16AL.5IN50.06B	14 949
760	700	16AL.3IN50.07B	11 489	16AL.4IN50.07B	13 927	16AL.5IN50.07B	16 366
860	800	16AL.3IN50.08B	12 339	16AL.4IN50.08B	15 061	16AL.5IN50.08B	17 784
960	900	16AL.3IN50.09B	13 418	16AL.4IN50.09B	16 500	16AL.5IN50.09B	19 581
1060	1000	16AL.3IN50.10B	14 268	16AL.4IN50.10B	17 634	16AL.5IN50.10B	20 999
1160	1100	16AL.3IN50.11B	15 119	16AL.4IN50.11B	18 768	16AL.5IN50.11B	22 417
1260	1200	16AL.3IN50.12B	15 969	16AL.4IN50.12B	19 902	16AL.5IN50.12B	23 834
1360	1300	16AL.3IN50.13B	17 048	16AL.4IN50.13B	21 340	16AL.5IN50.13B	25 632
1460	1400	16AL.3IN50.14B	17 898	16AL.4IN50.14B	22 474	16AL.5IN50.14B	27 049
1560	1500	16AL.3IN50.15B	18 749	16AL.4IN50.15B	23 608	16AL.5IN50.15B	28 467
1660	1600	16AL.3IN50.16B	19 599	16AL.4IN50.16B	24 742	16AL.5IN50.16B	29 884
1760	1700	16AL.3IN50.17B	20 678	16AL.4IN50.17B	26 180	16AL.5IN50.17B	31 682
1860	1800	16AL.3IN50.18B	21 528	16AL.4IN50.18B	27 314	16AL.5IN50.18B	33 099
Дополнительная линейная секция Additional line section / Elemento lineare aggiuntivo							
630	600	16AL.3IN50.06E	8 552	16AL.4IN50.06E	10 707	16AL.5IN50.06E	12 863
730	700	16AL.3IN50.07E	9 403	16AL.4IN50.07E	11 841	16AL.5IN50.07E	14 280
830	800	16AL.3IN50.08E	10 253	16AL.4IN50.08E	12 975	16AL.5IN50.08E	15 698
930	900	16AL.3IN50.09E	11 332	16AL.4IN50.09E	14 414	16AL.5IN50.09E	17 495
1030	1000	16AL.3IN50.10E	12 182	16AL.4IN50.10E	15 548	16AL.5IN50.10E	18 913
1130	1100	16AL.3IN50.11E	13 033	16AL.4IN50.11E	16 682	16AL.5IN50.11E	20 331
1230	1200	16AL.3IN50.12E	13 883	16AL.4IN50.12E	17 816	16AL.5IN50.12E	21 748
1330	1300	16AL.3IN50.13E	14 962	16AL.4IN50.13E	19 254	16AL.5IN50.13E	23 546
1430	1400	16AL.3IN50.14E	15 812	16AL.4IN50.14E	20 388	16AL.5IN50.14E	24 963
1530	1500	16AL.3IN50.15E	16 663	16AL.4IN50.15E	21 522	16AL.5IN50.15E	26 381
1630	1600	16AL.3IN50.16E	17 513	16AL.4IN50.16E	22 656	16AL.5IN50.16E	27 798
1730	1700	16AL.3IN50.17E	18 592	16AL.4IN50.17E	24 094	16AL.5IN50.17E	29 596
1830	1800	16AL.3IN50.18E	19 442	16AL.4IN50.18E	25 228	16AL.5IN50.18E	31 013
Угловая секция Corner section / Elemento angolare							
630	600	16AL.3IN50.06C	8 552	16AL.4IN50.06C	10 707	16AL.5IN50.06C	12 863
730	700	16AL.3IN50.07C	9 403	16AL.4IN50.07C	11 841	16AL.5IN50.07C	14 280
830	800	16AL.3IN50.08C	10 253	16AL.4IN50.08C	12 975	16AL.5IN50.08C	15 698
930	900	16AL.3IN50.09C	11 332	16AL.4IN50.09C	14 414	16AL.5IN50.09C	17 495
1030	1000	16AL.3IN50.10C	12 182	16AL.4IN50.10C	15 548	16AL.5IN50.10C	18 913
1130	1100	16AL.3IN50.11C	13 033	16AL.4IN50.11C	16 682	16AL.5IN50.11C	20 331
1230	1200	16AL.3IN50.12C	13 883	16AL.4IN50.12C	17 816	16AL.5IN50.12C	21 748
1330	1300	16AL.3IN50.13C	14 962	16AL.4IN50.13C	19 254	16AL.5IN50.13C	23 546
1430	1400	16AL.3IN50.14C	15 812	16AL.4IN50.14C	20 388	16AL.5IN50.14C	24 963
1530	1500	16AL.3IN50.15C	16 663	16AL.4IN50.15C	21 522	16AL.5IN50.15C	26 381
1630	1600	16AL.3IN50.16C	17 513	16AL.4IN50.16C	22 656	16AL.5IN50.16C	27 798
1730	1700	16AL.3IN50.17C	18 592	16AL.4IN50.17C	24 094	16AL.5IN50.17C	29 596
1830	1800	16AL.3IN50.18C	19 442	16AL.4IN50.18C	25 228	16AL.5IN50.18C	31 013

H. 1800
D. 300

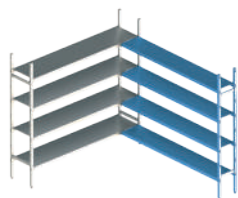
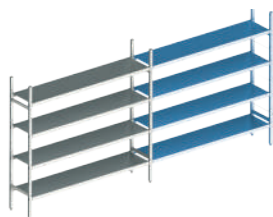

Общая длина, мм Total length, mm Lunghezza totale, mm	Длина полки, мм Shelf length, mm Lunghezza ripiano, mm	Цена, руб. / Price, rubles / Prezzo, rubli					
		3 яруса / 3 tiers / 3 livelli		4 яруса / 4 tiers / 4 livelli		5 ярусов / 5 tiers / 5 livelli	
Базовая секция Basic section / Elemento base							
660	600	18AL.3IN30.06B	9 071	18AL.4IN30.06B	10 750	18AL.5IN30.06B	12 429
760	700	18AL.3IN30.07B	9 677	18AL.4IN30.07B	11 558	18AL.5IN30.07B	13 439
860	800	18AL.3IN30.08B	10 251	18AL.4IN30.08B	12 323	18AL.5IN30.08B	14 395
960	900	18AL.3IN30.09B	11 136	18AL.4IN30.09B	13 504	18AL.5IN30.09B	15 871
1060	1000	18AL.3IN30.10B	11 742	18AL.4IN30.10B	14 311	18AL.5IN30.10B	16 881
1160	1100	18AL.3IN30.11B	12 335	18AL.4IN30.11B	15 102	18AL.5IN30.11B	17 869
1260	1200	18AL.3IN30.12B	12 953	18AL.4IN30.12B	15 926	18AL.5IN30.12B	18 899
1360	1300	18AL.3IN30.13B	13 807	18AL.4IN30.13B	17 065	18AL.5IN30.13B	20 322
1460	1400	18AL.3IN30.14B	14 413	18AL.4IN30.14B	17 872	18AL.5IN30.14B	21 332
1560	1500	18AL.3IN30.15B	15 018	18AL.4IN30.15B	18 680	18AL.5IN30.15B	22 341
1660	1600	18AL.3IN30.16B	15 624	18AL.4IN30.16B	19 487	18AL.5IN30.16B	23 350
1760	1700	18AL.3IN30.17B	16 478	18AL.4IN30.17B	20 626	18AL.5IN30.17B	24 774
1860	1800	18AL.3IN30.18B	17 083	18AL.4IN30.18B	21 433	18AL.5IN30.18B	25 783
Дополнительная линейная секция Additional line section / Elemento lineare aggiuntivo							
630	600	18AL.3IN30.06E	7 054	18AL.4IN30.06E	8 733	18AL.5IN30.06E	10 412
730	700	18AL.3IN30.07E	7 660	18AL.4IN30.07E	9 541	18AL.5IN30.07E	11 422
830	800	18AL.3IN30.08E	8 234	18AL.4IN30.08E	10 306	18AL.5IN30.08E	12 378
930	900	18AL.3IN30.09E	9 119	18AL.4IN30.09E	11 487	18AL.5IN30.09E	13 854
1030	1000	18AL.3IN30.10E	9 725	18AL.4IN30.10E	12 294	18AL.5IN30.10E	14 864
1130	1100	18AL.3IN30.11E	10 318	18AL.4IN30.11E	13 085	18AL.5IN30.11E	15 852
1230	1200	18AL.3IN30.12E	10 936	18AL.4IN30.12E	13 909	18AL.5IN30.12E	16 882
1330	1300	18AL.3IN30.13E	11 790	18AL.4IN30.13E	15 048	18AL.5IN30.13E	18 305
1430	1400	18AL.3IN30.14E	12 396	18AL.4IN30.14E	15 855	18AL.5IN30.14E	19 315
1530	1500	18AL.3IN30.15E	13 001	18AL.4IN30.15E	16 663	18AL.5IN30.15E	20 324
1630	1600	18AL.3IN30.16E	13 607	18AL.4IN30.16E	17 470	18AL.5IN30.16E	21 333
1730	1700	18AL.3IN30.17E	14 461	18AL.4IN30.17E	18 609	18AL.5IN30.17E	22 757
1830	1800	18AL.3IN30.18E	15 066	18AL.4IN30.18E	19 416	18AL.5IN30.18E	23 766
Угловая секция Corner section / Elemento angolare							
630	600	18AL.3IN30.06C	7 054	18AL.4IN30.06C	8 733	18AL.5IN30.06C	10 412
730	700	18AL.3IN30.07C	7 660	18AL.4IN30.07C	9 541	18AL.5IN30.07C	11 422
830	800	18AL.3IN30.08C	8 234	18AL.4IN30.08C	10 306	18AL.5IN30.08C	12 378
930	900	18AL.3IN30.09C	9 119	18AL.4IN30.09C	11 487	18AL.5IN30.09C	13 854
1030	1000	18AL.3IN30.10C	9 725	18AL.4IN30.10C	12 294	18AL.5IN30.10C	14 864
1130	1100	18AL.3IN30.11C	10 318	18AL.4IN30.11C	13 085	18AL.5IN30.11C	15 852
1230	1200	18AL.3IN30.12C	10 936	18AL.4IN30.12C	13 909	18AL.5IN30.12C	16 882
1330	1300	18AL.3IN30.13C	11 790	18AL.4IN30.13C	15 048	18AL.5IN30.13C	18 305
1430	1400	18AL.3IN30.14C	12 396	18AL.4IN30.14C	15 855	18AL.5IN30.14C	19 315
1530	1500	18AL.3IN30.15C	13 001	18AL.4IN30.15C	16 663	18AL.5IN30.15C	20 324
1630	1600	18AL.3IN30.16C	13 607	18AL.4IN30.16C	17 470	18AL.5IN30.16C	21 333
1730	1700	18AL.3IN30.17C	14 461	18AL.4IN30.17C	18 609	18AL.5IN30.17C	22 757
1830	1800	18AL.3IN30.18C	15 066	18AL.4IN30.18C	19 416	18AL.5IN30.18C	23 766

H. 1800
D. 400

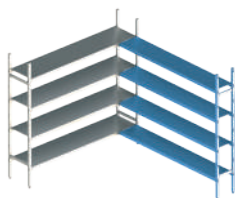
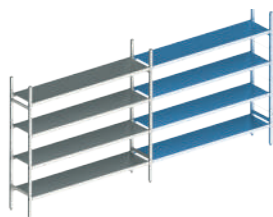

Общая длина, мм Total length, mm Lunghezza totale, mm	Длина полки, мм Shelf length, mm Lunghezza ripiano, mm	Цена, руб. / Price, rubles / Prezzo, rubli					
		3 яруса / 3 tiers / 3 livelli		4 яруса / 4 tiers / 4 livelli		5 ярусов / 5 tiers / 5 livelli	
Базовая секция Basic section / Elemento base							
660	600	18AL.3IN40.06B	10 026	18AL.4IN40.06B	11 940	18AL.5IN40.06B	13 854
760	700	18AL.3IN40.07B	10 690	18AL.4IN40.07B	12 825	18AL.5IN40.07B	14 961
860	800	18AL.3IN40.08B	11 354	18AL.4IN40.08B	13 711	18AL.5IN40.08B	16 068
960	900	18AL.3IN40.09B	12 443	18AL.4IN40.09B	15 163	18AL.5IN40.09B	17 883
1060	1000	18AL.3IN40.10B	13 108	18AL.4IN40.10B	16 049	18AL.5IN40.10B	18 990
1160	1100	18AL.3IN40.11B	13 772	18AL.4IN40.11B	16 935	18AL.5IN40.11B	20 097
1260	1200	18AL.3IN40.12B	14 436	18AL.4IN40.12B	17 820	18AL.5IN40.12B	21 205
1360	1300	18AL.3IN40.13B	15 525	18AL.4IN40.13B	19 273	18AL.5IN40.13B	23 020
1460	1400	18AL.3IN40.14B	16 190	18AL.4IN40.14B	20 158	18AL.5IN40.14B	24 127
1560	1500	18AL.3IN40.15B	16 854	18AL.4IN40.15B	21 044	18AL.5IN40.15B	25 234
1660	1600	18AL.3IN40.16B	17 518	18AL.4IN40.16B	21 930	18AL.5IN40.16B	26 341
1760	1700	18AL.3IN40.17B	18 607	18AL.4IN40.17B	23 382	18AL.5IN40.17B	28 156
1860	1800	18AL.3IN40.18B	19 272	18AL.4IN40.18B	24 267	18AL.5IN40.18B	29 263
Дополнительная линейная секция Additional line section / Elemento lineare aggiuntivo							
630	600	18AL.3IN40.06E	7 884	18AL.4IN40.06E	9 798	18AL.5IN40.06E	11 712
730	700	18AL.3IN40.07E	8 548	18AL.4IN40.07E	10 684	18AL.5IN40.07E	12 819
830	800	18AL.3IN40.08E	9 213	18AL.4IN40.08E	11 569	18AL.5IN40.08E	13 926
930	900	18AL.3IN40.09E	10 302	18AL.4IN40.09E	13 021	18AL.5IN40.09E	15 741
1030	1000	18AL.3IN40.10E	10 966	18AL.4IN40.10E	13 907	18AL.5IN40.10E	16 849
1130	1100	18AL.3IN40.11E	11 630	18AL.4IN40.11E	14 793	18AL.5IN40.11E	17 956
1230	1200	18AL.3IN40.12E	12 294	18AL.4IN40.12E	15 679	18AL.5IN40.12E	19 063
1330	1300	18AL.3IN40.13E	13 383	18AL.4IN40.13E	17 131	18AL.5IN40.13E	20 878
1430	1400	18AL.3IN40.14E	14 048	18AL.4IN40.14E	18 016	18AL.5IN40.14E	21 985
1530	1500	18AL.3IN40.15E	14 712	18AL.4IN40.15E	18 902	18AL.5IN40.15E	23 092
1630	1600	18AL.3IN40.16E	15 376	18AL.4IN40.16E	19 788	18AL.5IN40.16E	24 199
1730	1700	18AL.3IN40.17E	16 465	18AL.4IN40.17E	21 240	18AL.5IN40.17E	26 014
1830	1800	18AL.3IN40.18E	17 130	18AL.4IN40.18E	22 126	18AL.5IN40.18E	27 122
Угловая секция Corner section / Elemento angolare							
630	600	18AL.3IN40.06C	7 884	18AL.4IN40.06C	9 798	18AL.5IN40.06C	11 712
730	700	18AL.3IN40.07C	8 548	18AL.4IN40.07C	10 684	18AL.5IN40.07C	12 819
830	800	18AL.3IN40.08C	9 213	18AL.4IN40.08C	11 569	18AL.5IN40.08C	13 926
930	900	18AL.3IN40.09C	10 302	18AL.4IN40.09C	13 021	18AL.5IN40.09C	15 741
1030	1000	18AL.3IN40.10C	10 966	18AL.4IN40.10C	13 907	18AL.5IN40.10C	16 849
1130	1100	18AL.3IN40.11C	11 630	18AL.4IN40.11C	14 793	18AL.5IN40.11C	17 956
1230	1200	18AL.3IN40.12C	12 294	18AL.4IN40.12C	15 679	18AL.5IN40.12C	19 063
1330	1300	18AL.3IN40.13C	13 383	18AL.4IN40.13C	17 131	18AL.5IN40.13C	20 878
1430	1400	18AL.3IN40.14C	14 048	18AL.4IN40.14C	18 016	18AL.5IN40.14C	21 985
1530	1500	18AL.3IN40.15C	14 712	18AL.4IN40.15C	18 902	18AL.5IN40.15C	23 092
1630	1600	18AL.3IN40.16C	15 376	18AL.4IN40.16C	19 788	18AL.5IN40.16C	24 199
1730	1700	18AL.3IN40.17C	16 465	18AL.4IN40.17C	21 240	18AL.5IN40.17C	26 014
1830	1800	18AL.3IN40.18C	17 130	18AL.4IN40.18C	22 126	18AL.5IN40.18C	27 122

H. 1800
D. 500

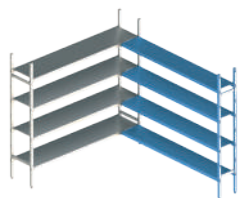
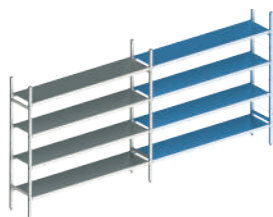

Общая длина, мм Total length, mm Lunghezza totale, mm	Длина полки, мм Shelf length, mm Lunghezza ripiano, mm	Цена, руб. / Price, rubles / Prezzo, rubli					
		3 яруса / 3 tiers / 3 livelli		4 яруса / 4 tiers / 4 livelli		5 ярусов / 5 tiers / 5 livelli	
Базовая секция Basic section / Elemento base							
660	600	18AL.3IN50.06B	11 000	18AL.4IN50.06B	13 155	18AL.5IN50.06B	15 311
760	700	18AL.3IN50.07B	11 851	18AL.4IN50.07B	14 289	18AL.5IN50.07B	16 728
860	800	18AL.3IN50.08B	12 701	18AL.4IN50.08B	15 423	18AL.5IN50.08B	18 146
960	900	18AL.3IN50.09B	13 780	18AL.4IN50.09B	16 862	18AL.5IN50.09B	19 943
1060	1000	18AL.3IN50.10B	14 630	18AL.4IN50.10B	17 996	18AL.5IN50.10B	21 361
1160	1100	18AL.3IN50.11B	15 481	18AL.4IN50.11B	19 130	18AL.5IN50.11B	22 779
1260	1200	18AL.3IN50.12B	16 331	18AL.4IN50.12B	20 264	18AL.5IN50.12B	24 196
1360	1300	18AL.3IN50.13B	17 410	18AL.4IN50.13B	21 702	18AL.5IN50.13B	25 994
1460	1400	18AL.3IN50.14B	18 260	18AL.4IN50.14B	22 836	18AL.5IN50.14B	27 411
1560	1500	18AL.3IN50.15B	19 111	18AL.4IN50.15B	23 970	18AL.5IN50.15B	28 829
1660	1600	18AL.3IN50.16B	19 961	18AL.4IN50.16B	25 104	18AL.5IN50.16B	30 246
1760	1700	18AL.3IN50.17B	21 040	18AL.4IN50.17B	26 542	18AL.5IN50.17B	32 044
1860	1800	18AL.3IN50.18B	21 890	18AL.4IN50.18B	27 676	18AL.5IN50.18B	33 461
Дополнительная линейная секция Additional line section / Elemento lineare aggiuntivo							
630	600	18AL.3IN50.06E	8 733	18AL.4IN50.06E	10 888	18AL.5IN50.06E	13 044
730	700	18AL.3IN50.07E	9 584	18AL.4IN50.07E	12 022	18AL.5IN50.07E	14 461
830	800	18AL.3IN50.08E	10 434	18AL.4IN50.08E	13 156	18AL.5IN50.08E	15 879
930	900	18AL.3IN50.09E	11 513	18AL.4IN50.09E	14 595	18AL.5IN50.09E	17 676
1030	1000	18AL.3IN50.10E	12 363	18AL.4IN50.10E	15 729	18AL.5IN50.10E	19 094
1130	1100	18AL.3IN50.11E	13 214	18AL.4IN50.11E	16 863	18AL.5IN50.11E	20 512
1230	1200	18AL.3IN50.12E	14 064	18AL.4IN50.12E	17 997	18AL.5IN50.12E	21 929
1330	1300	18AL.3IN50.13E	15 143	18AL.4IN50.13E	19 435	18AL.5IN50.13E	23 727
1430	1400	18AL.3IN50.14E	15 993	18AL.4IN50.14E	20 569	18AL.5IN50.14E	25 144
1530	1500	18AL.3IN50.15E	16 844	18AL.4IN50.15E	21 703	18AL.5IN50.15E	26 562
1630	1600	18AL.3IN50.16E	17 694	18AL.4IN50.16E	22 837	18AL.5IN50.16E	27 979
1730	1700	18AL.3IN50.17E	18 773	18AL.4IN50.17E	24 275	18AL.5IN50.17E	29 777
1830	1800	18AL.3IN50.18E	19 623	18AL.4IN50.18E	25 409	18AL.5IN50.18E	31 194
Угловая секция Corner section / Elemento angolare							
630	600	18AL.3IN50.06C	8 733	18AL.4IN50.06C	10 888	18AL.5IN50.06C	13 044
730	700	18AL.3IN50.07C	9 584	18AL.4IN50.07C	12 022	18AL.5IN50.07C	14 461
830	800	18AL.3IN50.08C	10 434	18AL.4IN50.08C	13 156	18AL.5IN50.08C	15 879
930	900	18AL.3IN50.09C	11 513	18AL.4IN50.09C	14 595	18AL.5IN50.09C	17 676
1030	1000	18AL.3IN50.10C	12 363	18AL.4IN50.10C	15 729	18AL.5IN50.10C	19 094
1130	1100	18AL.3IN50.11C	13 214	18AL.4IN50.11C	16 863	18AL.5IN50.11C	20 512
1230	1200	18AL.3IN50.12C	14 064	18AL.4IN50.12C	17 997	18AL.5IN50.12C	21 929
1330	1300	18AL.3IN50.13C	15 143	18AL.4IN50.13C	19 435	18AL.5IN50.13C	23 727
1430	1400	18AL.3IN50.14C	15 993	18AL.4IN50.14C	20 569	18AL.5IN50.14C	25 144
1530	1500	18AL.3IN50.15C	16 844	18AL.4IN50.15C	21 703	18AL.5IN50.15C	26 562
1630	1600	18AL.3IN50.16C	17 694	18AL.4IN50.16C	22 837	18AL.5IN50.16C	27 979
1730	1700	18AL.3IN50.17C	18 773	18AL.4IN50.17C	24 275	18AL.5IN50.17C	29 777
1830	1800	18AL.3IN50.18C	19 623	18AL.4IN50.18C	25 409	18AL.5IN50.18C	31 194

H. 2100
D. 300

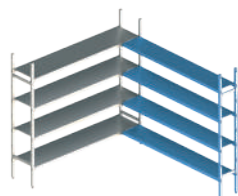
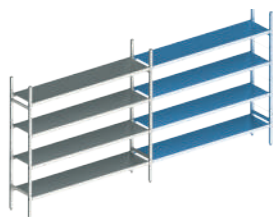

Общая длина, мм Total length, mm Lunghezza totale, mm	Длина полки, мм Shelf length, mm Lunghezza ripiano, mm	Цена, руб. / Price, rubles / Prezzo, rubli					
		3 яруса / 3 tiers / 3 livelli		4 яруса / 4 tiers / 4 livelli		5 ярусов / 5 tiers / 5 livelli	
Базовая секция Basic section / Elemento base							
660	600	21AL.3IN30.06B	9 615	21AL.4IN30.06B	11 294	21AL.5IN30.06B	12 973
760	700	21AL.3IN30.07B	10 221	21AL.4IN30.07B	12 102	21AL.5IN30.07B	13 983
860	800	21AL.3IN30.08B	10 795	21AL.4IN30.08B	12 867	21AL.5IN30.08B	14 939
960	900	21AL.3IN30.09B	11 680	21AL.4IN30.09B	14 048	21AL.5IN30.09B	16 415
1060	1000	21AL.3IN30.10B	12 286	21AL.4IN30.10B	14 855	21AL.5IN30.10B	17 425
1160	1100	21AL.3IN30.11B	12 879	21AL.4IN30.11B	15 646	21AL.5IN30.11B	18 413
1260	1200	21AL.3IN30.12B	13 497	21AL.4IN30.12B	16 470	21AL.5IN30.12B	19 443
1360	1300	21AL.3IN30.13B	14 351	21AL.4IN30.13B	17 609	21AL.5IN30.13B	20 866
1460	1400	21AL.3IN30.14B	14 957	21AL.4IN30.14B	18 416	21AL.5IN30.14B	21 876
1560	1500	21AL.3IN30.15B	15 562	21AL.4IN30.15B	19 224	21AL.5IN30.15B	22 885
1660	1600	21AL.3IN30.16B	16 168	21AL.4IN30.16B	20 031	21AL.5IN30.16B	23 894
1760	1700	21AL.3IN30.17B	17 022	21AL.4IN30.17B	21 170	21AL.5IN30.17B	25 318
1860	1800	21AL.3IN30.18B	17 627	21AL.4IN30.18B	21 977	21AL.5IN30.18B	26 327
Дополнительная линейная секция Additional line section / Elemento lineare aggiuntivo							
630	600	21AL.3IN30.06E	7 326	21AL.4IN30.06E	9 005	21AL.5IN30.06E	10 684
730	700	21AL.3IN30.07E	7 932	21AL.4IN30.07E	9 813	21AL.5IN30.07E	11 694
830	800	21AL.3IN30.08E	8 506	21AL.4IN30.08E	10 578	21AL.5IN30.08E	12 650
930	900	21AL.3IN30.09E	9 391	21AL.4IN30.09E	11 759	21AL.5IN30.09E	14 126
1030	1000	21AL.3IN30.10E	9 997	21AL.4IN30.10E	12 566	21AL.5IN30.10E	15 136
1130	1100	21AL.3IN30.11E	10 590	21AL.4IN30.11E	13 357	21AL.5IN30.11E	16 124
1230	1200	21AL.3IN30.12E	11 208	21AL.4IN30.12E	14 181	21AL.5IN30.12E	17 154
1330	1300	21AL.3IN30.13E	12 062	21AL.4IN30.13E	15 320	21AL.5IN30.13E	18 577
1430	1400	21AL.3IN30.14E	12 668	21AL.4IN30.14E	16 127	21AL.5IN30.14E	19 587
1530	1500	21AL.3IN30.15E	13 273	21AL.4IN30.15E	16 935	21AL.5IN30.15E	20 596
1630	1600	21AL.3IN30.16E	13 879	21AL.4IN30.16E	17 742	21AL.5IN30.16E	21 605
1730	1700	21AL.3IN30.17E	14 733	21AL.4IN30.17E	18 881	21AL.5IN30.17E	23 029
1830	1800	21AL.3IN30.18E	15 338	21AL.4IN30.18E	19 688	21AL.5IN30.18E	24 038
Угловая секция Corner section / Elemento angolare							
630	600	21AL.3IN30.06C	7 326	21AL.4IN30.06C	9 005	21AL.5IN30.06C	10 684
730	700	21AL.3IN30.07C	7 932	21AL.4IN30.07C	9 813	21AL.5IN30.07C	11 694
830	800	21AL.3IN30.08C	8 506	21AL.4IN30.08C	10 578	21AL.5IN30.08C	12 650
930	900	21AL.3IN30.09C	9 391	21AL.4IN30.09C	11 759	21AL.5IN30.09C	14 126
1030	1000	21AL.3IN30.10C	9 997	21AL.4IN30.10C	12 566	21AL.5IN30.10C	15 136
1130	1100	21AL.3IN30.11C	10 590	21AL.4IN30.11C	13 357	21AL.5IN30.11C	16 124
1230	1200	21AL.3IN30.12C	11 208	21AL.4IN30.12C	14 181	21AL.5IN30.12C	17 154
1330	1300	21AL.3IN30.13C	12 062	21AL.4IN30.13C	15 320	21AL.5IN30.13C	18 577
1430	1400	21AL.3IN30.14C	12 668	21AL.4IN30.14C	16 127	21AL.5IN30.14C	19 587
1530	1500	21AL.3IN30.15C	13 273	21AL.4IN30.15C	16 935	21AL.5IN30.15C	20 596
1630	1600	21AL.3IN30.16C	13 879	21AL.4IN30.16C	17 742	21AL.5IN30.16C	21 605
1730	1700	21AL.3IN30.17C	14 733	21AL.4IN30.17C	18 881	21AL.5IN30.17C	23 029
1830	1800	21AL.3IN30.18C	15 338	21AL.4IN30.18C	19 688	21AL.5IN30.18C	24 038

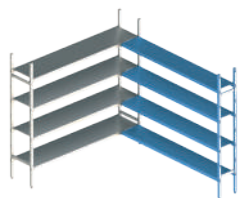
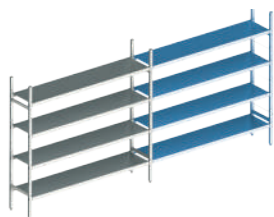
H. 2100
D. 400

Общая длина, мм Total length, mm Lunghezza totale, mm	Длина полки, мм Shelf length, mm Lunghezza ripiano, mm	Цена, руб. / Price, rubles / Prezzo, rubli					
		3 яруса / 3 tiers / 3 livelli		4 яруса / 4 tiers / 4 livelli		5 ярусов / 5 tiers / 5 livelli	
Базовая секция Basic section / Elemento base							
660	600	21AL.3IN40.06B	10 570	21AL.4IN40.06B	12 484	21AL.5IN40.06B	14 398
760	700	21AL.3IN40.07B	11 234	21AL.4IN40.07B	13 370	21AL.5IN40.07B	15 505
860	800	21AL.3IN40.08B	11 899	21AL.4IN40.08B	14 256	21AL.5IN40.08B	16 612
960	900	21AL.3IN40.09B	12 988	21AL.4IN40.09B	15 708	21AL.5IN40.09B	18 428
1060	1000	21AL.3IN40.10B	13 652	21AL.4IN40.10B	16 593	21AL.5IN40.10B	19 535
1160	1100	21AL.3IN40.11B	14 316	21AL.4IN40.11B	17 479	21AL.5IN40.11B	20 642
1260	1200	21AL.3IN40.12B	14 981	21AL.4IN40.12B	18 365	21AL.5IN40.12B	21 749
1360	1300	21AL.3IN40.13B	16 070	21AL.4IN40.13B	19 817	21AL.5IN40.13B	23 564
1460	1400	21AL.3IN40.14B	16 734	21AL.4IN40.14B	20 703	21AL.5IN40.14B	24 671
1560	1500	21AL.3IN40.15B	17 398	21AL.4IN40.15B	21 588	21AL.5IN40.15B	25 778
1660	1600	21AL.3IN40.16B	18 063	21AL.4IN40.16B	22 474	21AL.5IN40.16B	26 886
1760	1700	21AL.3IN40.17B	19 152	21AL.4IN40.17B	23 926	21AL.5IN40.17B	28 701
1860	1800	21AL.3IN40.18B	19 816	21AL.4IN40.18B	24 812	21AL.5IN40.18B	29 808
Дополнительная линейная секция Additional line section / Elemento lineare aggiuntivo							
630	600	21AL.3IN40.06E	8 156	21AL.4IN40.06E	10 070	21AL.5IN40.06E	11 984
730	700	21AL.3IN40.07E	8 820	21AL.4IN40.07E	10 956	21AL.5IN40.07E	13 091
830	800	21AL.3IN40.08E	9 485	21AL.4IN40.08E	11 842	21AL.5IN40.08E	14 198
930	900	21AL.3IN40.09E	10 574	21AL.4IN40.09E	13 294	21AL.5IN40.09E	16 014
1030	1000	21AL.3IN40.10E	11 238	21AL.4IN40.10E	14 179	21AL.5IN40.10E	17 121
1130	1100	21AL.3IN40.11E	11 902	21AL.4IN40.11E	15 065	21AL.5IN40.11E	18 228
1230	1200	21AL.3IN40.12E	12 567	21AL.4IN40.12E	15 951	21AL.5IN40.12E	19 335
1330	1300	21AL.3IN40.13E	13 656	21AL.4IN40.13E	17 403	21AL.5IN40.13E	21 150
1430	1400	21AL.3IN40.14E	14 320	21AL.4IN40.14E	18 289	21AL.5IN40.14E	22 257
1530	1500	21AL.3IN40.15E	14 984	21AL.4IN40.15E	19 174	21AL.5IN40.15E	23 364
1630	1600	21AL.3IN40.16E	15 649	21AL.4IN40.16E	20 060	21AL.5IN40.16E	24 472
1730	1700	21AL.3IN40.17E	16 738	21AL.4IN40.17E	21 512	21AL.5IN40.17E	26 287
1830	1800	21AL.3IN40.18E	17 402	21AL.4IN40.18E	22 398	21AL.5IN40.18E	27 394
Угловая секция Corner section / Elemento angolare							
630	600	21AL.3IN40.06C	8 156	21AL.4IN40.06C	10 070	21AL.5IN40.06C	11 984
730	700	21AL.3IN40.07C	8 820	21AL.4IN40.07C	10 956	21AL.5IN40.07C	13 091
830	800	21AL.3IN40.08C	9 485	21AL.4IN40.08C	11 842	21AL.5IN40.08C	14 198
930	900	21AL.3IN40.09C	10 574	21AL.4IN40.09C	13 294	21AL.5IN40.09C	16 014
1030	1000	21AL.3IN40.10C	11 238	21AL.4IN40.10C	14 179	21AL.5IN40.10C	17 121
1130	1100	21AL.3IN40.11C	11 902	21AL.4IN40.11C	15 065	21AL.5IN40.11C	18 228
1230	1200	21AL.3IN40.12C	12 567	21AL.4IN40.12C	15 951	21AL.5IN40.12C	19 335
1330	1300	21AL.3IN40.13C	13 656	21AL.4IN40.13C	17 403	21AL.5IN40.13C	21 150
1430	1400	21AL.3IN40.14C	14 320	21AL.4IN40.14C	18 289	21AL.5IN40.14C	22 257
1530	1500	21AL.3IN40.15C	14 984	21AL.4IN40.15C	19 174	21AL.5IN40.15C	23 364
1630	1600	21AL.3IN40.16C	15 649	21AL.4IN40.16C	20 060	21AL.5IN40.16C	24 472
1730	1700	21AL.3IN40.17C	16 738	21AL.4IN40.17C	21 512	21AL.5IN40.17C	26 287
1830	1800	21AL.3IN40.18C	17 402	21AL.4IN40.18C	22 398	21AL.5IN40.18C	27 394

H. 2100
D. 500

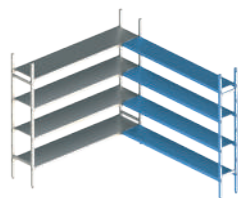
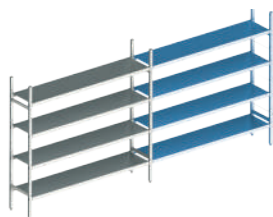

Общая длина, мм Total length, mm Lunghezza totale, mm	Длина полки, мм Shelf length, mm Lunghezza ripiano, mm	Цена, руб. / Price, rubles / Prezzo, rubli					
		3 яруса / 3 tiers / 3 livelli		4 яруса / 4 tiers / 4 livelli		5 ярусов / 5 tiers / 5 livelli	
Базовая секция Basic section / Elemento base							
660	600	21AL.3IN50.06B	11 544	21AL.4IN50.06B	13 699	21AL.5IN50.06B	15 855
760	700	21AL.3IN50.07B	12 395	21AL.4IN50.07B	14 833	21AL.5IN50.07B	17 272
860	800	21AL.3IN50.08B	13 245	21AL.4IN50.08B	15 967	21AL.5IN50.08B	18 690
960	900	21AL.3IN50.09B	14 324	21AL.4IN50.09B	17 406	21AL.5IN50.09B	20 487
1060	1000	21AL.3IN50.10B	15 174	21AL.4IN50.10B	18 540	21AL.5IN50.10B	21 905
1160	1100	21AL.3IN50.11B	16 025	21AL.4IN50.11B	19 674	21AL.5IN50.11B	23 323
1260	1200	21AL.3IN50.12B	16 875	21AL.4IN50.12B	20 808	21AL.5IN50.12B	24 740
1360	1300	21AL.3IN50.13B	17 954	21AL.4IN50.13B	22 246	21AL.5IN50.13B	26 538
1460	1400	21AL.3IN50.14B	18 804	21AL.4IN50.14B	23 380	21AL.5IN50.14B	27 955
1560	1500	21AL.3IN50.15B	19 655	21AL.4IN50.15B	24 514	21AL.5IN50.15B	29 373
1660	1600	21AL.3IN50.16B	20 505	21AL.4IN50.16B	25 648	21AL.5IN50.16B	30 790
1760	1700	21AL.3IN50.17B	21 584	21AL.4IN50.17B	27 086	21AL.5IN50.17B	32 588
1860	1800	21AL.3IN50.18B	22 434	21AL.4IN50.18B	28 220	21AL.5IN50.18B	34 005
Дополнительная линейная секция Additional line section / Elemento lineare aggiuntivo							
630	600	21AL.3IN50.06E	9 005	21AL.4IN50.06E	11 160	21AL.5IN50.06E	13 316
730	700	21AL.3IN50.07E	9 856	21AL.4IN50.07E	12 294	21AL.5IN50.07E	14 733
830	800	21AL.3IN50.08E	10 706	21AL.4IN50.08E	13 428	21AL.5IN50.08E	16 151
930	900	21AL.3IN50.09E	11 785	21AL.4IN50.09E	14 867	21AL.5IN50.09E	17 948
1030	1000	21AL.3IN50.10E	12 635	21AL.4IN50.10E	16 001	21AL.5IN50.10E	19 366
1130	1100	21AL.3IN50.11E	13 486	21AL.4IN50.11E	17 135	21AL.5IN50.11E	20 784
1230	1200	21AL.3IN50.12E	14 336	21AL.4IN50.12E	18 269	21AL.5IN50.12E	22 201
1330	1300	21AL.3IN50.13E	15 415	21AL.4IN50.13E	19 707	21AL.5IN50.13E	23 999
1430	1400	21AL.3IN50.14E	16 265	21AL.4IN50.14E	20 841	21AL.5IN50.14E	25 416
1530	1500	21AL.3IN50.15E	17 116	21AL.4IN50.15E	21 975	21AL.5IN50.15E	26 834
1630	1600	21AL.3IN50.16E	17 966	21AL.4IN50.16E	23 109	21AL.5IN50.16E	28 251
1730	1700	21AL.3IN50.17E	19 045	21AL.4IN50.17E	24 547	21AL.5IN50.17E	30 049
1830	1800	21AL.3IN50.18E	19 895	21AL.4IN50.18E	25 681	21AL.5IN50.18E	31 466
Угловая секция Corner section / Elemento angolare							
630	600	21AL.3IN50.06C	9 005	21AL.4IN50.06C	11 160	21AL.5IN50.06C	13 316
730	700	21AL.3IN50.07C	9 856	21AL.4IN50.07C	12 294	21AL.5IN50.07C	14 733
830	800	21AL.3IN50.08C	10 706	21AL.4IN50.08C	13 428	21AL.5IN50.08C	16 151
930	900	21AL.3IN50.09C	11 785	21AL.4IN50.09C	14 867	21AL.5IN50.09C	17 948
1030	1000	21AL.3IN50.10C	12 635	21AL.4IN50.10C	16 001	21AL.5IN50.10C	19 366
1130	1100	21AL.3IN50.11C	13 486	21AL.4IN50.11C	17 135	21AL.5IN50.11C	20 784
1230	1200	21AL.3IN50.12C	14 336	21AL.4IN50.12C	18 269	21AL.5IN50.12C	22 201
1330	1300	21AL.3IN50.13C	15 415	21AL.4IN50.13C	19 707	21AL.5IN50.13C	23 999
1430	1400	21AL.3IN50.14C	16 265	21AL.4IN50.14C	20 841	21AL.5IN50.14C	25 416
1530	1500	21AL.3IN50.15C	17 116	21AL.4IN50.15C	21 975	21AL.5IN50.15C	26 834
1630	1600	21AL.3IN50.16C	17 966	21AL.4IN50.16C	23 109	21AL.5IN50.16C	28 251
1730	1700	21AL.3IN50.17C	19 045	21AL.4IN50.17C	24 547	21AL.5IN50.17C	30 049
1830	1800	21AL.3IN50.18C	19 895	21AL.4IN50.18C	25 681	21AL.5IN50.18C	31 466



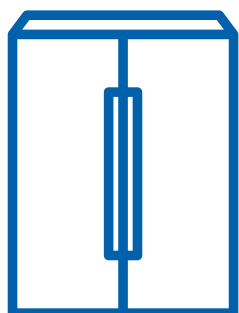

ВАРИАНТЫ РАЗМЕЩЕНИЯ СТЕЛЛАЖЕЙ В ХОЛОДИЛЬНЫХ КАМЕРАХ

ALLOCATION OPTIONS FOR SHELVING
IN REFRIGERATING CAMERAS

ESEMPI
DI POSIZIONAMENTO SCAFFALATURE
ALL'INTERNO DELLE CELLE

КХН-2,94 КХН-2,94 / КХН-2,94

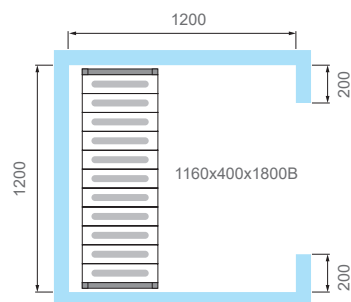

H=1800; D=400

Ярусы / Tiers / Livelli	Артикул / Артикул / Артикул	Цена* / Price* / Prezzo*
3	18AL.3PP40.11B	9 577
4	18AL.4PP40.11B	11 410
5	18AL.5PP40.11B	13 243

КХН-4,41 КХН-4,41 / КХН-4,41

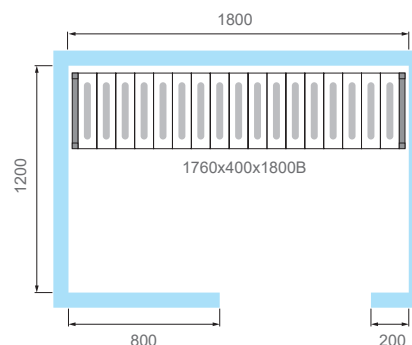

H=1800; D=400

Ярусы / Tiers / Livelli	Артикул / Артикул / Артикул	Цена* / Price* / Prezzo*
3	18AL.3PP40.17B	12 150
4	18AL.4PP40.17B	14 840
5	18AL.5PP40.17B	17 531

*Цена за комплект стеллажей с полипропиленовыми полками

*Price for shelving set with polypropylene shelves / *Prezzo per composizione scaffalature con ripiani in polipropilene

КХН-6,61

Вариант 1 / Variant 1 / Composizione 1

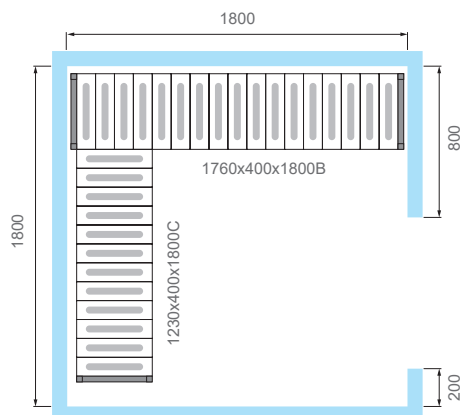

H=1800; D=400

Ярусы / Tiers / Livelli	Артикул / Артикул / Артикул	Цена* / Price* / Prezzo*
3	18AL.3PP40.17B 18AL.3PP40.12C	20 121
4	18AL.4PP40.17B 18AL.4PP40.12C	24 787
5	18AL.5PP40.17B 18AL.5PP40.12C	29 452

Вариант 2 / Variant 2 / Composizione 2

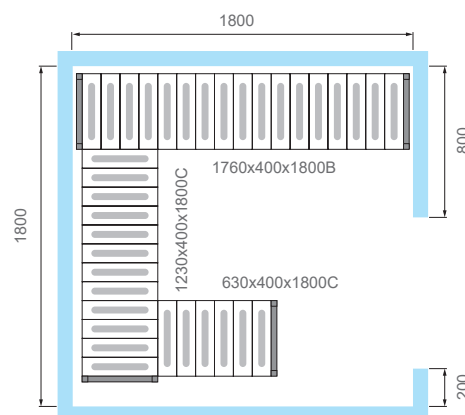

H=1800; D=400

Ярусы / Tiers / Livelli	Артикул / Артикул / Артикул	Цена* / Price* / Prezzo*
3	18AL.3PP40.17B 18AL.3PP40.12C 18AL.3PP40.06C	25 520
4	18AL.4PP40.17B 18AL.4PP40.12C 18AL.4PP40.06C	31 306
5	18AL.5PP40.17B 18AL.5PP40.12C 18AL.5PP40.06C	37 086

*Цена за комплект стеллажей с полипропиленовыми полками

*Price for shelving set with polypropylene shelves / *Prezzo per composizione scaffalature con ripiani in polipropilene

KXH-7,71

Вариант 1 / Variant 1 / Composizione 1

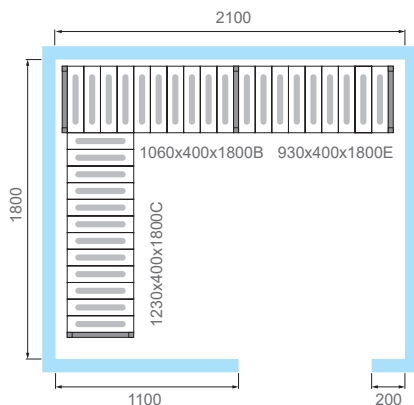

H=1800; D=400

Ярусы / Tiers / Livelli	Артикул / Артикул / Артикул	Цена* / Price* / Prezzo*
3	18AL.3PP40.10B 18AL.3PP40.09E 18AL.3PP40.12C	23 805
4	18AL.4PP40.10B 18AL.4PP40.09E 18AL.4PP40.12C	29 018
5	18AL.5PP40.10B 18AL.5PP40.09E 18AL.5PP40.12C	34 227

Вариант 2 / Variant 2 / Composizione 2

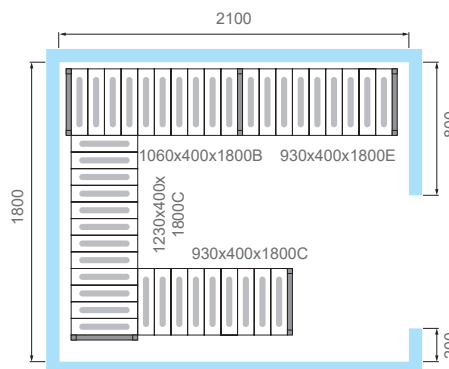

H=1800; D=400

Ярусы / Tiers / Livelli	Артикул / Артикул / Артикул	Цена* / Price* / Prezzo*
3	18AL.3PP40.10B 18AL.3PP40.09E 18AL.3PP40.12C 18AL.3PP40.09C	30 490
4	18AL.4PP40.10B 18AL.4PP40.09E 18AL.4PP40.12C 18AL.4PP40.09C	37 250
5	18AL.5PP40.10B 18AL.5PP40.09E 18AL.5PP40.12C 18AL.5PP40.09C	44 004

KXH-8,81

Вариант 1 / Variant 1 / Composizione 1

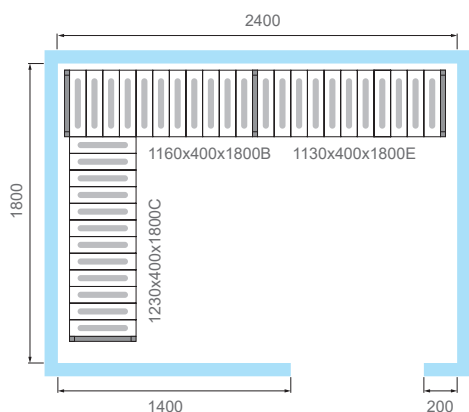

H=1800; D=400

Ярусы / Tiers / Livelli	Артикул / Артикул / Артикул	Цена* / Price* / Prezzo*
3	18AL.3PP40.11B 18AL.3PP40.11E 18AL.3PP40.12C	25 091
4	18AL.4PP40.11B 18AL.4PP40.11E 18AL.4PP40.12C	30 733
5	18AL.5PP40.11B 18AL.5PP40.11E 18AL.5PP40.12C	36 371

Вариант 2 / Variant 2 / Composizione 2

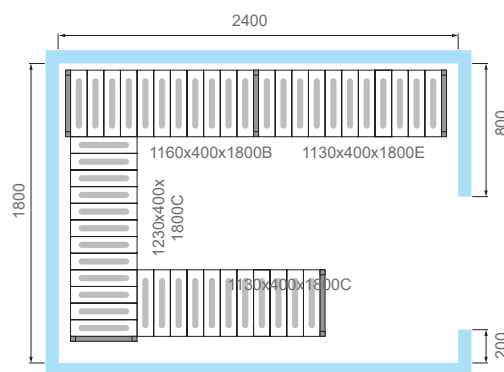

H=1800; D=400

Ярусы / Tiers / Livelli	Артикул / Артикул / Артикул	Цена* / Price* / Prezzo*
3	18AL.3PP40.11B 18AL.3PP40.11E 18AL.3PP40.12C 18AL.3PP40.11C	32 634
4	18AL.4PP40.11B 18AL.4PP40.11E 18AL.4PP40.12C 18AL.4PP40.11C	40 109
5	18AL.5PP40.11B 18AL.5PP40.11E 18AL.5PP40.12C 18AL.5PP40.11C	47 578

*Цена за комплект стеллажей с полипропиленовыми полками

*Price for shelving set with polypropylene shelves / *Prezzo per composizione scaffalature con ripiani in polipropilene

KXH-11,02

Вариант 1 / Variant 1 / Composizione 1

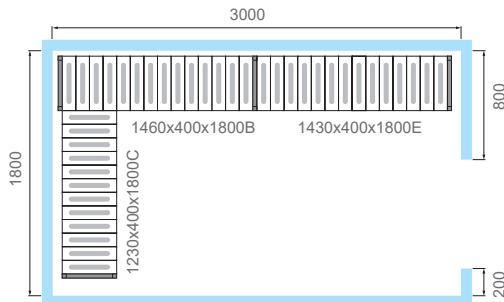

H=1800; D=400

Ярусы / Tiers / Livelli	Артикул / Артикул / Артикул	Цена* / Price* / Prezzo*
3	18AL.3PP40.14B 18AL.3PP40.14E 18AL.3PP40.12C	27 664
4	18AL.4PP40.14B 18AL.4PP40.14E 18AL.4PP40.12C	34 163
5	18AL.5PP40.14B 18AL.5PP40.14E 18AL.5PP40.12C	40 658

Вариант 2 / Variant 2 / Composizione 2

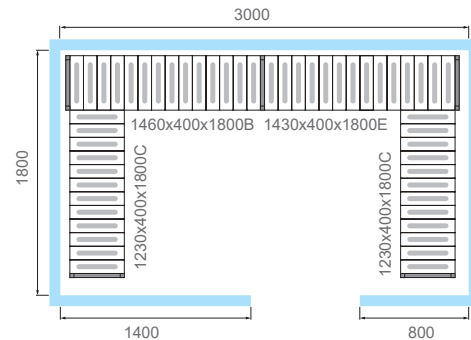

H=1800; D=400

Ярусы / Tiers / Livelli	Артикул / Артикул / Артикул	Цена* / Price* / Prezzo*
3	18AL.3PP40.14B 18AL.3PP40.14E 18AL.3PP40.12C-2	35 635
4	18AL.4PP40.14B 18AL.4PP40.14E 18AL.4PP40.12C-2	44 110
5	18AL.5PP40.14B 18AL.5PP40.14E 18AL.5PP40.12C-2	52 579

KXH-11,75

Вариант 1 / Variant 1 / Composizione 1

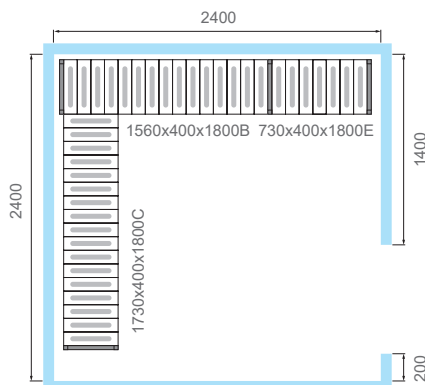

H=1800; D=400

Ярусы / Tiers / Livelli	Артикул / Артикул / Артикул	Цена* / Price* / Prezzo*
3	18AL.3PP40.15B 18AL.3PP40.07E 18AL.3PP40.17C	27 235
4	18AL.4PP40.15B 18AL.4PP40.07E 18AL.4PP40.17C	33 593
5	18AL.5PP40.15B 18AL.5PP40.07E 18AL.5PP40.17C	39 944

Вариант 2 / Variant 2 / Composizione 2

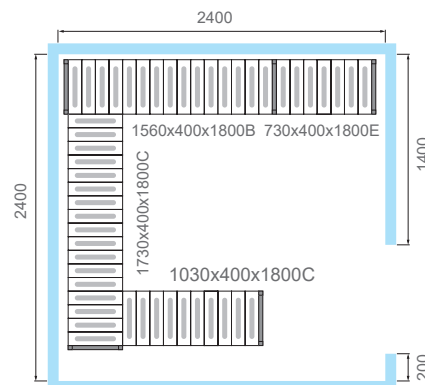

H=1800; D=400

Ярусы / Tiers / Livelli	Артикул / Артикул / Артикул	Цена* / Price* / Prezzo*
3	18AL.3PP40.15B 18AL.3PP40.07E 18AL.3PP40.17C 18AL.3PP40.10C	34 349
4	18AL.4PP40.15B 18AL.4PP40.07E 18AL.4PP40.17C 18AL.4PP40.10C	42 397
5	18AL.5PP40.15B 18AL.5PP40.07E 18AL.5PP40.17C 18AL.5PP40.10C	50 436

*Цена за комплект стеллажей с полипропиленовыми полками

*Price for shelving set with polypropylene shelves / *Prezzo per composizione scaffalature con ripiani in polipropilene



ДЛЯ ЗАМЕТОК

FOR NOTES

PAGINE NOTE





POLAIR



Подробную информацию о поставщиках оборудования POLAIR в вашем регионе смотрите на сайте www.polair.com в разделе «Где купить»

Detailed information about POLAIR suppliers in your region you can get at www.polair.com in section «Where to buy» / Le informazioni per l'acquisto dei prodotti POLAIR nelle diverse aree si può trovare sul sito www.polair.com alla sezione «Dove comprare»

www.polair.com
www.polairgroup.ru
sales_russia@polair.com



@polair.polair



@polairgroup