

# NERONE®

## CONVECTION OVENS

TRANSLATION OF THE ORIGINAL INSTRUCTIONS

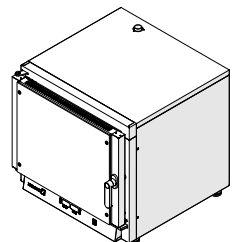
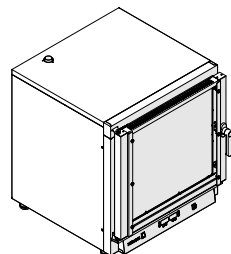
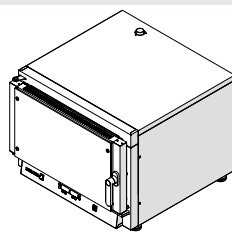
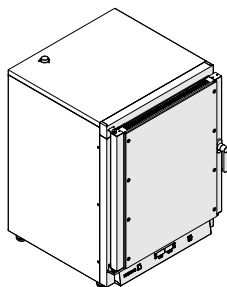
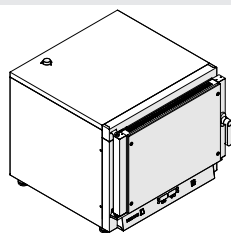

# MID

Revision 00 - 06/2021



**EN** USE AND MAINTENANCE MANUAL



# TABLE OF CONTENTS

<b>TABLE OF CONTENTS</b> .....	<b>3</b>	<b>7. CONTROL PANELS</b> .....	<b>31</b>
<b>TECHNICAL DATA SHEETS</b> .....	<b>5</b>	7.1. "DIGITAL" version control panel .....	31
<b>TECHNICAL DATA SHEETS</b> .....	<b>11</b>	7.1.1. <i>Display</i> .....	32
<b>USE AND MAINTENANCE MANUAL</b> .....	<b>17</b>	7.1.2. <i>Keyboard functionality and user interface</i> .....	32
<b>1. GENERAL PRELIMINARY INFORMATION</b> .....	<b>18</b>	7.2. "MECHANICAL" version control panel .....	33
1.1. Purpose of the document .....	18	<b>8. USE</b> .....	<b>34</b>
1.2. Supply and preservation .....	18	8.1. First use .....	34
1.3. Symbols used in the manual .....	18	8.2. Activation .....	34
1.4. Regulatory framework .....	19	8.3. Product loading and cooking .....	35
1.5. Warranty .....	19	8.3.1. <i>Product loading</i> .....	35
<b>2. SAFETY WARNINGS</b> .....	<b>20</b>	8.3.2. <i>Set a cooking</i> .....	35
2.1. Obligations and prohibitions .....	21	8.3.3. <i>New recipe creation (ONLY "DIGITAL" VERSION)</i> .....	37
2.1.1. <i>Obligations</i> .....	21	8.3.4. <i>Cooking with recipe already saved (ONLY "DIGITAL" VERSION)</i> .....	37
2.1.2. <i>Prohibitions</i> .....	21	8.3.5. <i>H<sub>2</sub>O injection adjustment (ONLY "DIGITAL" VERSION)</i> .....	38
<b>3. IDENTIFICATION AND DESCRIPTION</b> .....	<b>22</b>	8.3.6. <i>Cooking with core probe and <math>\Delta^{\circ}T</math> (ONLY "DIGITAL" VERSION)</i> .....	38
3.1. Equipment identification .....	22	<b>8.4. Other functions</b> .....	<b>39</b>
3.2. Intended use .....	22	8.5. Switching off .....	40
3.3. Description .....	23	<b>9. CLEANING</b> .....	<b>41</b>
3.3.1. <i>Types of cooking and ovens</i> .....	23	9.1. Cleaning safety warnings .....	41
3.4. Main components .....	24	9.2. Clean the cooking chamber .....	42
<b>4. RECEIPT AND HANDLING</b> .....	<b>25</b>	9.3. Cleaning the glass .....	42
4.1. Equipment receipt .....	25	9.4. Special Cleaning of the cooking chamber .....	43
4.1.1. <i>Packaging removal and inspection</i> .....	25	<b>10. MAINTENANCE</b> .....	<b>44</b>
4.1.2. <i>Packaging disposal</i> .....	25	10.1. Routine maintenance .....	44
4.2. Handling .....	26	10.1.1. <i>Inspecting after delivery</i> .....	44
<b>5. INSTALLATION</b> .....	<b>27</b>	<b>10.2. Extraordinary maintenance</b> .....	<b>44</b>
5.1. Installation site .....	27	10.2.1. <i>Door disassembly for maintenance operations</i> .....	45
5.1.1. <i>Features of installation site</i> .....	27	10.2.2. <i>Door gasket replacement</i> .....	46
5.1.2. <i>Minimum safety distances</i> .....	28	10.2.3. <i>Internal glass disassembly / replacement</i> .....	47
5.2. Positioning on support structure .....	28	10.2.4. <i>Tray supports disassembly</i> .....	48
5.3. Fumes exhaust - hood installation .....	29	10.2.5. <i>Lamp replacement</i> .....	49
<b>6. CONNECTIONS</b> .....	<b>30</b>	<b>11. DIAGNOSTICS</b> .....	<b>50</b>
6.1. Electrical connection .....	30	11.1. Probes alarm .....	50
6.1.1. <i>Electrical power supply connection</i> .....	30	11.2. Actions on the adjustment in progress .....	50
6.1.2. <i>Equipotential clamp connection</i> .....	30	11.3. Signals .....	50
<b>7. CONTROL PANELS</b> .....	<b>31</b>	<b>12. DECOMMISSIONING AND DISPOSAL</b> .....	<b>51</b>
7.1. "DIGITAL" version control panel .....	31	12.1. Long periods of inactivity .....	51
7.1.1. <i>Display</i> .....	32	12.2. Disposal .....	51
7.1.2. <i>Keyboard functionality and user interface</i> .....	32		
7.2. "MECHANICAL" version control panel .....	33		
<b>8. USE</b> .....	<b>34</b>		
8.1. First use .....	34		
8.2. Activation .....	34		
8.3. Product loading and cooking .....	35		
8.3.1. <i>Product loading</i> .....	35		
8.3.2. <i>Set a cooking</i> .....	35		
8.3.3. <i>New recipe creation (ONLY "DIGITAL" VERSION)</i> .....	37		
8.3.4. <i>Cooking with recipe already saved (ONLY "DIGITAL" VERSION)</i> .....	37		
8.3.5. <i>H<sub>2</sub>O injection adjustment (ONLY "DIGITAL" VERSION)</i> .....	38		
8.3.6. <i>Cooking with core probe and <math>\Delta^{\circ}T</math> (ONLY "DIGITAL" VERSION)</i> .....	38		
<b>8.4. Other functions</b> .....	<b>39</b>		
<b>8.5. Switching off</b> .....	<b>40</b>		
<b>9. CLEANING</b> .....	<b>41</b>		
9.1. Cleaning safety warnings .....	41		
9.2. Clean the cooking chamber .....	42		
9.3. Cleaning the glass .....	42		
9.4. Special Cleaning of the cooking chamber .....	43		
<b>10. MAINTENANCE</b> .....	<b>44</b>		
10.1. Routine maintenance .....	44		
10.1.1. <i>Inspecting after delivery</i> .....	44		
<b>10.2. Extraordinary maintenance</b> .....	<b>44</b>		
10.2.1. <i>Door disassembly for maintenance operations</i> .....	45		
10.2.2. <i>Door gasket replacement</i> .....	46		
10.2.3. <i>Internal glass disassembly / replacement</i> .....	47		
10.2.4. <i>Tray supports disassembly</i> .....	48		
10.2.5. <i>Lamp replacement</i> .....	49		
<b>11. DIAGNOSTICS</b> .....	<b>50</b>		
11.1. Probes alarm .....	50		
11.2. Actions on the adjustment in progress .....	50		
11.3. Signals .....	50		
<b>12. DECOMMISSIONING AND DISPOSAL</b> .....	<b>51</b>		
12.1. Long periods of inactivity .....	51		
12.2. Disposal .....	51		



# TECHNICAL DATA SHEETS

---



# 04 trays/grids

Digital convection oven, with or without water injection, capacity **4** trays or grids **600x400** mm or **GN 1/1**



LH SWING DOOR  
(standard)



RH SWING DOOR  
(optional)



## FUNCTIONS



CONVECTION



DIRECTION  
INVERSION



CORE PROBE



DELTA T°



H<sub>2</sub>O



RECIPES



LIGHT

## TECHNICAL FEATURES

Version	Electrical - Digital
Trays capacity	4 - 600x400 mm / 4 - GN 1/1
Distance between trays	80 mm
Chamber dimensions	L 680 x P 520 x H 360 mm
External dimensions	L 840 x P 910 x H 670 mm
Total electrical power	5.45 kW
Voltage	220-240 V / 380-415 V 3/3+N 50/60 Hz
Total power consumption	24.8 A
Packaging dimensions	L 880 x P 955 x H 820 mm
Net weight	79 kg
Gross weight with packaging	101 kg

# 05 trays/grids

Digital convection oven, with or without water injection, capacity **5** trays or grids **600x400** mm or **GN 1/1**



LH SWING DOOR  
(standard)



RH SWING DOOR  
(optional)



## FUNCTIONS



CONVECTION



DIRECTION  
INVERSION



CORE PROBE



DELTA T°



H<sub>2</sub>O



RECIPES



LIGHT

## TECHNICAL FEATURES

Version	Electrical - Digital
Trays capacity	5 - 600x400 mm / 5 - GN 1/1
Distance between trays	80 mm
Chamber dimensions	L 680 x P 480 x H 440 mm
External dimensions	L 840 x P 910 x H 750 mm
Total electrical power	6.45 kW
Voltage	220-240 V / 380-415 V 3/3+N 50/60 Hz
Total power consumption	29.3 A
Packaging dimensions	L 880 x P 955 x H 900 mm
Net weight	87 kg
Gross weight with packaging	109 kg

# 06 trays/grids

Digital convection oven, with or without water injection, capacity **6** trays or grids **600x400** mm or **GN 1/1**



LH SWING DOOR  
(standard)



RH SWING DOOR  
(optional)



## FUNCTIONS



CONVECTION



DIRECTION  
INVERSION



CORE PROBE



DELTA T°



H<sub>2</sub>O



RECIPES



LIGHT

## TECHNICAL FEATURES

Version	Electrical - Digital
Trays capacity	6 - 600x400 mm / 6 - GN 1/1
Distance between trays	80 mm
Chamber dimensions	L 680 x P 480 x H 520 mm
External dimensions	L 840 x P 910 x H 830 mm
Total electrical power	7.65 kW
Voltage	220-240 V / 380-415 V 3/3+N 50/60 Hz
Total power consumption	35 A
Packaging dimensions	L 880 x P 955 x H 980 mm
Net weight	91 kg
Gross weight with packaging	114 kg



# 07 trays/grids

Digital convection oven, with or without water injection, capacity **7** trays or grids **600x400** mm or **GN 1/1**



LH SWING DOOR  
(standard)



RH SWING DOOR  
(optional)



## FUNCTIONS



CONVECTION



DIRECTION  
INVERSION



CORE PROBE



DELTA T°



H<sub>2</sub>O



RECIPES



LIGHT

## TECHNICAL FEATURES

Version	Electrical - Digital
Trays capacity	7 - 600x400 mm / 7 - GN 1/1
Distance between trays	80 mm
Chamber dimensions	L 680 x P 520 x H 620 mm
External dimensions	L 840 x P 910 x H 930 mm
Total electrical power	10.7 kW
Voltage	220-240 V / 380-415 V 3/3+N 50/60 Hz
Total power consumption	49 A
Packaging dimensions	L 880 x P 955 x H 1080 mm
Net weight	106 kg
Gross weight with packaging	129 kg

# 10 trays/grids

Digital convection oven, with or without water injection, capacity **10** trays or grids **600x400** mm or **GN 1/1**



LH SWING DOOR  
(standard)



RH SWING DOOR  
(optional)



## FUNCTIONS



CONVECTION



DIRECTION  
INVERSION



CORE PROBE



DELTA T°



H<sub>2</sub>O



RECIPES



LIGHT

## TECHNICAL FEATURES

Version	Electrical - Digital
Trays capacity	10 - 600x400 mm / 10 - GN 1/1
Distance between trays	80 mm
Chamber dimensions	L 680 x P 480 x H 840 mm
External dimensions	L 840 x P 910 x H 1150 mm
Total electrical power	12.7 kW
Voltage	220-240 V / 380-415 V 3/3+N 50/60 Hz
Total power consumption	58 A
Packaging dimensions	L 880 x P 955 x H 1300 mm
Net weight	127 kg
Gross weight with packaging	150 Kg

# TECHNICAL DATA SHEETS

---



# 04 trays/grids

Mechanical convection oven, with or without water injection, capacity 4 trays or grids 600x400 mm or GN 1/1



LH SWING DOOR  
(standard)



RH SWING DOOR  
(optional)



## FUNCTIONS



CONVECTION



DIRECTION  
INVERSION



H<sub>2</sub>O



LIGHT

## TECHNICAL FEATURES

Version	Electrical - Mechanical
Trays capacity	4 - 600x400 mm / 4 - GN 1/1
Distance between trays	80 mm
Chamber dimensions	L 680 x P 520 x H 360 mm
External dimensions	L 840 x P 910 x H 670 mm
Total electrical power	5.45 kW
Voltage	220-240 V / 380-415 V 3/3+N 50/60 Hz
Total power consumption	24.8 A
Packaging dimensions	L 880 x P 955 x H 820 mm
Net weight	79 kg
Gross weight with packaging	101 kg

# 05 trays/grids

Mechanical convection oven, with or without water injection, capacity **5 trays or grids 600x400 mm** or **GN 1/1**



LH SWING DOOR  
(standard)



RH SWING DOOR  
(optional)



## FUNCTIONS



CONVECTION



DIRECTION  
INVERSION



H<sub>2</sub>O



LIGHT

## TECHNICAL FEATURES

Version	Electrical - Mechanical
Trays capacity	5 - 600x400 mm / 5 - GN 1/1
Distance between trays	80 mm
Chamber dimensions	L 680 x P 480 x H 440 mm
External dimensions	L 840 x P 910 x H 750 mm
Total electrical power	6.45 kW
Voltage	220-240 V / 380-415 V 3/3+N 50/60 Hz
Total power consumption	29.3 A
Packaging dimensions	L 880 x P 955 x H 900 mm
Net weight	87 kg
Gross weight with packaging	109 kg

# 06 trays/grids

Mechanical convection oven, with or without water injection, capacity **6** trays or grids **600x400** mm or **GN 1/1**



LH SWING DOOR  
(standard)



RH SWING DOOR  
(optional)



## FUNCTIONS



CONVECTION



DIRECTION  
INVERSION



H<sub>2</sub>O



LIGHT

## TECHNICAL FEATURES

Version	Electrical - Mechanical
Trays capacity	6 - 600x400 mm / 6 - GN 1/1
Distance between trays	80 mm
Chamber dimensions	L 680 x P 480 x H 520 mm
External dimensions	L 840 x P 910 x H 830 mm
Total electrical power	7.65 kW
Voltage	220-240 V / 380-415 V 3/3+N 50/60 Hz
Total power consumption	35 A
Packaging dimensions	L 880 x P 955 x H 980 mm
Net weight	91 kg
Gross weight with packaging	114 kg

# 07 trays/grids

Mechanical convection oven, with or without water injection, capacity **7 trays or grids 600x400 mm** or **GN 1/1**



LH SWING DOOR  
(standard)



RH SWING DOOR  
(optional)



## FUNCTIONS



CONVECTION



DIRECTION  
INVERSION



H<sub>2</sub>O



LIGHT

## TECHNICAL FEATURES

Version	Electrical - Mechanical
Trays capacity	7 - 600x400 mm / 7 - GN 1/1
Distance between trays	80 mm
Chamber dimensions	L 680 x P 520 x H 620 mm
External dimensions	L 840 x P 910 x H 930 mm
Total electrical power	10.7 kW
Voltage	220-240 V / 380-415 V 3/3+N 50/60 Hz
Total power consumption	49 A
Packaging dimensions	L 880 x P 955 x H 1080 mm
Net weight	106 kg
Gross weight with packaging	129 kg

# 10 trays/grids

Mechanical convection oven, with or without water injection, capacity **10** trays or grids **600x400** mm or **GN 1/1**



LH SWING DOOR  
(standard)



RH SWING DOOR  
(optional)



## FUNCTIONS



CONVECTION



DIRECTION  
INVERSION



H<sub>2</sub>O



LIGHT

## TECHNICAL FEATURES

Version	Electrical - Mechanical
Trays capacity	10 - 600x400 mm / 10 - GN 1/1
Distance between trays	80 mm
Chamber dimensions	L 680 x P 480 x H 840 mm
External dimensions	L 840 x P 910 x H 1150 mm
Total electrical power	12.7 kW
Voltage	220-240 V / 380-415 V 3/3+N 50/60 Hz
Total power consumption	58 A
Packaging dimensions	L 880 x P 955 x H 1300 mm
Net weight	127 kg
Gross weight with packaging	150 Kg



# USE AND MAINTENANCE MANUAL

---

# 1. GENERAL PRELIMINARY INFORMATION

**Thank you for purchasing one of our products.**

**Carefully read this manual before carrying out installation, maintenance and/or before using the equipment.**

This manual is attached to all versions of the equipment **NERONEMID**.

The Manufacturer is not liable for breakages, accidents or various problems due to non-compliance with and in any case the non-application of the provisions contained in this manual.

## 1.1. PURPOSE OF THE DOCUMENT

This **User and Maintenance Manual** represents the reference document, drawn up by the manufacturer of the equipment, aimed at operators and specialised personnel who will come into contact with it during its entire life cycle.

The purpose of the document is to provide information for the correct use of the machine, from installation to disposal, bringing attention to the dangers that may arise from incorrect use and taking into account the reasonably foreseeable incorrect behaviour of the operator.

## 1.2. SUPPLY AND PRESERVATION

The manual is supplied in **electronic format**.



This manual is an integral part of the equipment.

Keep this manual in a place that is accessible to all users for future consultation. In case of transfer or sale of the equipment, be sure to provide the new user with this manual, so that they may be properly informed about the installation procedure, the use and safety requirements.

## 1.3. SYMBOLS USED IN THE MANUAL

Symbols are used throughout the manual to emphasise information of significant importance.

The ones used are provided below:

SYMBOL	TYPE	DESCRIPTION
	WARNING	Symbol used to identify important warnings for the safety of the operator and/or equipment.
	FORBIDDEN	Symbol used to identify operations that must not be performed or behaviours that must not be adopted as they could cause personal injury or damage to the machine.
	OBLIGATION	Symbol used to identify particularly important information inside the manual. The information also regards the safety of personnel involved in use of the equipment.

## 1.4. REGULATORY FRAMEWORK

The equipment has been designed according to the regulatory framework described in the declarations of conformity accompanying the product and the identification plate placed on the same, as well as requirements, which can be downloaded directly from the manufacturer's website.

## 1.5. WARRANTY

The warranty terms established by law apply. Should the product be faulty, contact the nearest Authorised Service Centre, or the reference Dealer.

The following documentation must be forwarded in order to repair the equipment;

- copy of the invoice with the date of purchase of the product;
- description of the fault.

## 2. SAFETY WARNINGS



The Manufacturer cannot be held liable for any damage, suffered by people or things, caused by non-compliance with the aforementioned requirements or deriving from tampering with even a single part of the equipment and from the use of non-original spare parts.



Do not place flammable materials and or heat sources close to the oven (min. safety distance 0.6 m laterally).



This professional equipment can only be used and cleaned by adults (> 18 years in Europe or other limits defined by the local regulatory framework) with normal physical and mental health and adequately trained and informed on the subject of health and safety in the workplace.



Hot steam may flow out during oven operation. Burns hazard!



During operation, the cooking chamber reaches high temperatures. Do not touch the internal parts of the oven. Always use the special oven gloves to extract and insert trays. Danger of burns due to contact!



All operations regarding maintenance and replacement of parts must be carried out by qualified technical personnel.



The power supply must be disconnected before carrying out maintenance, control, cleaning operations.



It is strictly forbidden to make changes to the equipment.



Do not start the equipment with wet hands or when there is contact with water.



Replace any broken or faulty components only with original spare parts.

## 2.1. OBLIGATIONS AND PROHIBITIONS

### 2.1.1. OBLIGATIONS

- To install the equipment, follow the instructions in the **“INSTALLATION” chapter**. Installation must be carried out exclusively by qualified technical personnel.
- Make sure there are no electrical cables for other devices close to the oven and that they are not touching the hot parts.
- Keep children and pets away from the device during operation or cooling. The accessible parts are extremely hot.
- During operation of the device, only use baking trays that are suitable for the purpose.

### 2.1.2. PROHIBITIONS

- Do not install the equipment if it appears damaged upon receipt.
- Do not allow children to play with the equipment.
- Do not use the equipment as a work surface or as a support surface.
- Do not place or keep flammable liquids or materials, or easily ignitable objects inside the equipment or in the immediate vicinity.
- Do not place the oven next to walls, dividers, decorations, plastic sheets or sealing materials, since the walls of the oven could be hot and therefore damage said materials (formation of bubbles or deformations of the surface, detachment of the coating).
- Do not use trays with borders higher than necessary. The borders are barriers for air circulation.
- Do not lift the oven by holding the handle or by the front glass, hold it from the sides.
- Do not place the oven under direct exposure to sunlight and all other forms of thermal radiation.
- Do not place the product inside a room with high relative humidity (potential formation of condensate).
- Do not place the product inside a closed recess or close to a wall.
- Do not store flammable liquids or gasses close to the oven; in fact, this could cause fires if the device is started accidentally.
- Do not obstruct the air vents of the oven.
- Do not use the oven in recessed position.
- Do not rest the oven on any type of material, boxes or others, leaving all of its perimeter free to provide air recirculation. It is also good practice to keep the entire area around the equipment free and clean.
- Do not put foods wrapped in tinfoil, plastic containers or rags in the hot cooking areas.
- Do not place hot materials like containers, grids and/or trays on the oven.
- Do not place heavy objects on the open oven door to prevent damaging it.
- Do not use the cooking surface as a support base or working surface.
- Do not hang any weight on the handle of the oven door.
- Do not leave the device unsupervised when it is operating.
- Do not touch the surfaces when the device is operating. Burn hazard!
- Do not use damaged, inadequately sized and/or badly positioned trays.
- Do not heat trays without food.
- Do not modify or tamper with the equipment in any way.
- Do not place objects sensitive to heat or flammable (e.g. pot holders, curtains, alcohol bottles, etc...) inside the cooking compartment.

## 3. IDENTIFICATION AND DESCRIPTION

### 3.1. EQUIPMENT IDENTIFICATION

An identification plate is placed on the side of the equipment, which shows:

- the serial number,
- the type/functional features,
- the details of the certification and marking.



**It is strictly prohibited to remove the identification plate and/or replace it with other plates. Should the plate be damaged, detached or removed for accidental reasons, the customer must inform the Manufacturer.**

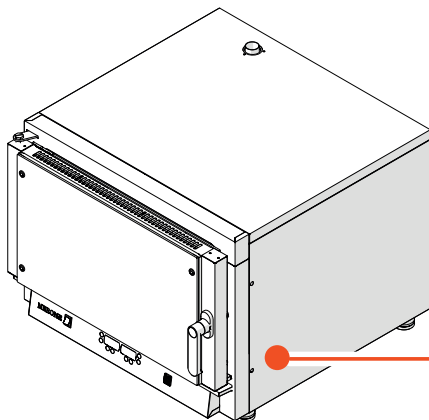

P.IVA: IT03589500283			
Data produzione Production date	Matricola	Serial Number	Modello Modulo
<input type="text"/>	<input type="text"/>	<input type="text"/>	<input type="text"/>
<b>Potenza Elettrica Totale</b> Total Electric Power		<b>FORNO Elettrico</b> Electric OVEN	
<input type="text"/>			
Tensione Alimentazione Power Supply	Fase Phase	Frequenza Frequency	
<input type="text"/>	<input type="text"/>	<input type="text"/>	
VIA ISONZO 3-5 - 35010 VIGODARZERE (PD) - ITALY Tel +39 0498874215 Fax +39 0498870507 Email: info@tecnodomspa.com Web: www.tecnodomspa.com			

### 3.2. INTENDED USE

The equipment covered by this manual is a **CONVECTION OVEN** for professional use belonging to the **Nerone MID** line. It has been designed and built for cooking food, like brioche and/or bread.

The Manufacturer cannot be held liable for uses other than those indicated.



**Do not use this device to heat rooms.**

### 3.3. DESCRIPTION

The device object of this manual is a **CONVECTION OVEN** for professional use, **for internal use**, to be used **to cook food and not for storage**, in the versions with electrical power supply.

#### 3.3.1. TYPES OF COOKING AND OVENS





##### CONVECTION COOKING

ICON	TYPE OF COOKING	DESCRIPTION
	<b>CONVECTION COOKING PLUS FANS RESISTANCE</b>	The oven is equipped with mechanical ventilation that allows an even distribution of hot air inside the cooking chamber

##### COOKING WITH T DELTA (optional)

ICON	TYPE OF COOKING	DESCRIPTION
	<b>COOKING WITH T DELTA (optional)</b>	Cooking which maintains the temperature difference between the cooking chamber and the core probe constant.

##### COOKING WITH FUNCTIONS (versions with resistance in the cooking chamber)

ICON	TYPE OF COOKING	DESCRIPTION
	<b>STEAM H<sub>2</sub>O</b>	Water injection in the cooking chamber, in manual or automatic mode
	<b>COOKING WITH CORE PROBE AND <math>\Delta^{\circ}\text{T}</math></b>	Cooking which maintains the temperature difference between the cooking chamber and the core probe constant.
	<b>ONLY VENTILATION (COOLING)</b>	
	<b>CONVECTION PLUS FANS RESISTANCE</b>	The oven is equipped with mechanical ventilation that allows an even distribution of hot air inside the cooking chamber

##### REGENERATION

ICON	TYPE OF COOKING	DESCRIPTION
-	<b>REGENERATION</b>	Optimal heating and regeneration of previously prepared or flash frozen foods.

## 3.4. MAIN COMPONENTS

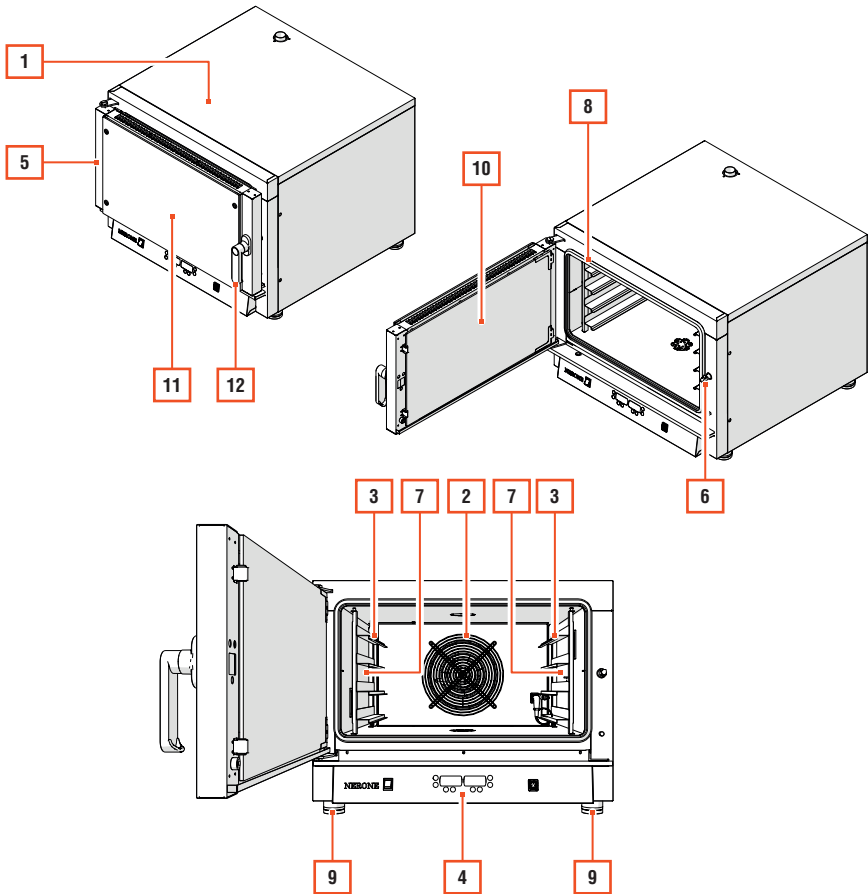

POS.	ELEMENT
1	OVEN STRUCTURE
2	FANS PROTECTION CASING
3	TRAYS/GRIDS SUPPORT
4	CONTROL PANEL
5	OVEN OPENING DOOR
6	DOOR SAFETY MICROSWITCH
7	LAMP
8	DOOR GASKET

POS.	ELEMENT
9	FEET
10	INTERNAL GLASS
11	EXTERNAL GLASS
12	DOOR OPENING HANDLE
-	SAFETY THERMOSTAT
-	FAN MOTOR
-	RESISTANCE



## 4. RECEIPT AND HANDLING

### 4.1. EQUIPMENT RECEIPT

The device is delivered on a pallet and packaged with a strapped cardboard.

**Upon delivery, check that the packaging is intact and that it has not been damaged during transport.**

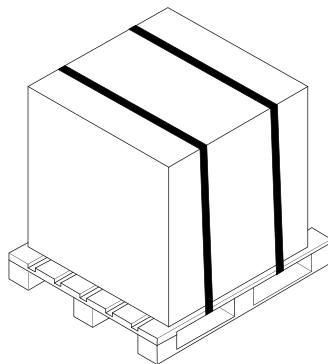

#### 4.1.1. PACKAGING REMOVAL AND INSPECTION

Upon receipt of the equipment, proceed with its unpacking:

STEP	ACTION
1	Remove the bands.
2	Remove the packaging cardboard.
3	Manually lift the oven to move it from the pallet and place it on a support structure. <b>Note:</b> no.2 people are required to manually move the oven.
4	Remove the plastic covers and the user manual inside the cooking chamber.

After removing all packaging materials, check for any anomalies.

**In case of anomalies**, do not carry out the installation operations and contact the Manufacturer within 8 days from the date of purchase, reporting the data shown on the identification plate of the equipment and any problems encountered.

#### 4.1.2. PACKAGING DISPOSAL

The materials used for the packaging are recyclable and must be collected according to the regulations concerning separate waste collection.



**Separate the various packaging waste materials and dispose of them in compliance with the regulations in force in the country where the oven is installed.**

## 4.2. HANDLING

Carefully read the instructions before moving the equipment.



**The equipment must always and only be transported in a horizontal position.  
Do not tilt the product!**

No.2 operators are required for lifting/handling.

To move the equipment it is therefore required to lift it manually, grabbing it from under the base.



**Pay attention during handling so as not to cause damage to the equipment itself, to people, animals and things in the immediate vicinity.**



**Do not pull the equipment by the door opening handle to move it.**

## 5. INSTALLATION



The installation, and all the interventions on the equipment described in this instruction manual, must be performed by qualified technical personnel and in compliance with current regulations.



The device must not be installed in an area where risk of fire is present. When heat sources are present, keep a side and rear distance of 0.6 m. If there are no other heat sources present, 0.1 m is enough.



The device must be installed on a support structure built in non-flammable material, suitable to support its weight. The structure must be safe in order to avoid sagging, falls or tipping over of the device. Furthermore, it must not protrude by more than 0.3 m beyond the device on all sides.

### 5.1. INSTALLATION SITE



The device cannot be installed and operated in ATEX classified environments, areas or areas where explosive atmospheres may be present, the deposit of any dusts or other substances must be eliminated with suitable cleaning in order to avoid starting fires/explosions, especially with the heated surfaces.

#### 5.1.1. FEATURES OF INSTALLATION SITE



**The equipment was not designed for outdoor operation.**

**It is not allowed to install the equipment outdoors and in locations directly exposed to the weather.**

The equipment must be placed indoors, in a room ventilated and suitable for the purpose (e.g. kitchen). It cannot be used outside the permitted usage and operating conditions.

#### PERMITTED ENVIRONMENTAL CONDITIONS

Ambient temperature	min. + 15°C / max + 30°C
Air humidity	max 90%

### 5.1.2. MINIMUM SAFETY DISTANCES

In order to provide a good performance of the device, respect the minimum safety distance from the side walls, other devices and/or heat sources.



**Maintain a minimum safety distance of 0.6 m from other heat sources. 0.1 m is enough if there are no other heat sources present.**

#### MINIMUM SAFETY DISTANCES

A	Lateral with presence of other heat sources nearby	min 0.6 mm
	Lateral/upper without presence of other heat sources nearby	min 0.1 mm
B	Front	min 0.9 mm

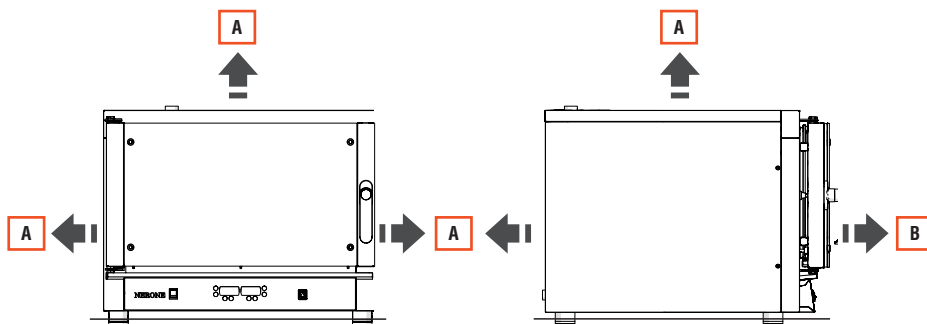

### 5.2. POSITIONING ON SUPPORT STRUCTURE

The base of the support structure must be built in non flammable material, which adequately supports its weight with a safe structure which prevents sagging, falls or tipping over of the device.

To **position the equipment** on the support structure, proceed as described below:

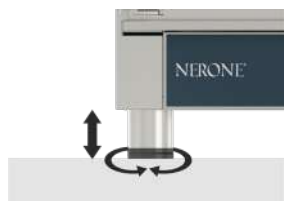

STEP	ACTION
1	Place the equipment in a perfectly vertical position on the support structure.
2	Act (if necessary) on the screw operated feet adjustment of the device.
3	Check the flatness with a spirit level.

### 5.3. FUMES EXHAUST - HOOD INSTALLATION

The device must be used in combination with a suction hood.

The fumes exhaust chimney is placed in the rear, upper part of the oven.

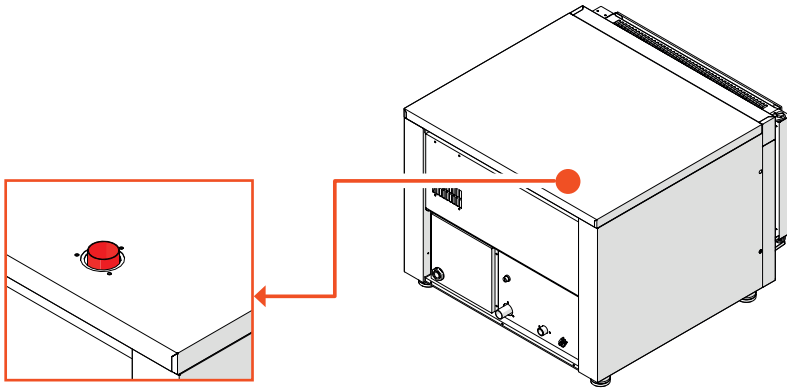

**Do not cover the fume exhaust chimney!**

The user must install a hood above the oven and guarantee a high rate of ventilation in the environment where it is installed.

**To install the hood, consult the hood assembly instructions that show the correct distance to be provided.**

## 6. CONNECTIONS

### 6.1. ELECTRICAL CONNECTION

#### 6.1.1. ELECTRICAL POWER SUPPLY CONNECTION



**The electrical connection must be carried out by a qualified technician. The installation and electrical connections must be carried out in compliance with the legal framework and regulations applicable in the countries where the equipment is to be installed.**

The following is required to **perform a correct electrical connection**:

- provide a differential magnetothermal switch and make sure that the frequency/voltage of the line corresponds to the one shown on the product's identification plate.
- check the power supply voltage at the connection and the  $\pm 10\%$  nominal at start up.
- install a bipolar cut-off switch with opening of the contacts at least 3 mm, upstream of the plug. This switch is compulsory when the load exceeds 1000 Watt or when connected directly without using the plug and must be placed in the immediate vicinity of the oven so that it can be easily seen by the technician in case of maintenance.
- **only for three-phase oven:** Install a switch downstream with a contacts opening distance which allows complete disconnection in the overtension III category conditions, in compliance with the installation rules.
- that the section of the power cable must be suitable for the power absorbed by the oven.
- The earthing of the system is required by law, therefore it is required to connect it to an efficient earthing system.

Proceed as follows:

STEP	ACTION
1	Unscrew the 4 screws that fasten the cover of the electrical panel compartment and open it.
2	Pass the power supply cable in the cable gland present on the cover and tighten it.
3	Connect the power supply cable to terminals N - L1 - L2 - L3.



**If the power supply cable is damaged, it must be replaced by the Manufacturer, an authorised technician or a person qualified to avoid dangerous situations.**



**The Manufacturer declines any liability for incorrect connections, not performed in a workmanlike manner or performed by non-professionally qualified persons.**

#### 6.1.2. EQUIPOTENTIAL CLAMP CONNECTION











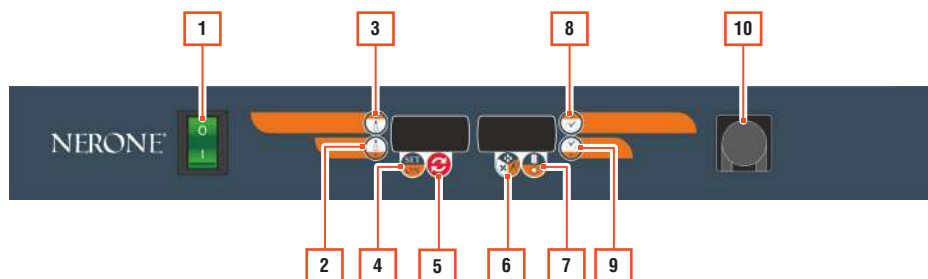

Connect the oven to the earthing system and insert it in the equipotential circuit. The clamp used for this purpose is on the back of the oven and is marked by the international symbol in the figure.

## 7. CONTROL PANELS

### 7.1. "DIGITAL" VERSION CONTROL PANEL

The "DIGITAL" version control panel has 8 buttons. The main functions on each button are shown below. The buttons may have secondary functions determined by pressing them with other buttons and pressing time.



POS.	ICON	ELEMENT
1		MAIN SWITCH O/I
2		TEMPERATURE REDUCTION - $\Delta T$
3		TEMPERATURE INCREASE $\Delta T$
4		ON/OFF - SET H <sub>2</sub> O
5		PRE-HEAT - START - STOP - COOKING CYCLE
6		H <sub>2</sub> O INJECTION - COOKING WITH CORE PROBE - COOLING
7		RECIPES - LIGHTS ON IN COOKING CHAMBER
8		TIME INCREASE - CORE PROBE
9		TIME REDUCTION - CORE PROBE
10		CONNECTION FOR CORE PROBE

### 7.1.1. DISPLAY

The “**DIGITAL**” version control panel is fitted with:

- two for four digit,
- no. 14 icons to display the output status, used to display the inlets, set-points, the parameters and their values, the alarms, the functions, the statuses.

The segments of the numbers are red whilst the icons can be of various colours (red, yellow, green, blue).







### 7.1.2. KEYBOARD FUNCTIONALITY AND USER INTERFACE

Pressing button (1) “MAIN SWITCH”, puts the oven in “Standby”.

The machine activates by pressing button (4) “ON/OFF - SET PARAMETERS”  and allows a quick setting of the cooking functions with consequent cycle start.

there are 5 available parameters:

- 1  Cooking temperature
- 2  Cooking time
- 3  Stop probe temperature (where included)
- 4  Water flow amount (through the injection cycle percentage) (where included)
- 5  $\Delta T^{\circ}$   $\Delta T^{\circ}$  Temperature differential

#### Manual parameter settings

Press buttons (3-2) UP  DOWN  to set the cooking temperature that will be shown on the left hand display.

Press buttons (8-9) UP  DOWN  (Infinite time “inF” button (9) DOWN  below zero) to set the cooking time.







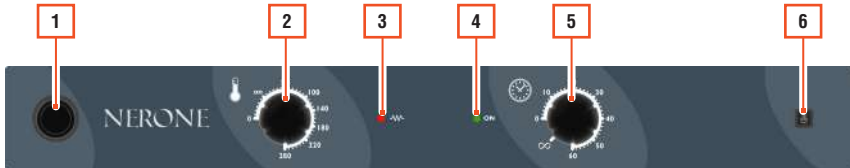

## 7.2. “MECHANICAL” VERSION CONTROL PANEL

The “**MECHANICAL**” version control panel has 2 adjustment knobs and 2 status indicator lights.

The main functions are shown below.



POS.	ICON	ELEMENT
1		MANUAL RE-ENGAGEMENT
2		TEMPERATURE KNOB
3		RESISTANCE LIGHT
4		LIGHT “ON”
5		TIME HANDLE
6		H <sub>2</sub> O INJECTION

## 8. USE



Before use, it is required to check that the oven is in perfect condition. In the presence of faults, the equipment must be decommissioned and the Technical Assistance Service must be contacted.

### 8.1. FIRST USE



Before switch-on, it is recommended to carefully clean the equipment and its components as indicated in the chapter "CLEANING".



When using the oven for the first it is suggested to perform an empty operation cycle (heating the oven above 200°C), in order to remove the impurities on the construction materials.

### 8.2. ACTIVATION



Do not start the equipment with wet hands or when there is contact with water.

Make sure that the oven door is closed before switch-on. If open, the safety microswitch is tripped and stops oven switch-on/operation. It will resume operations once the door is closed.

To **switch on the oven**, proceed as described below according to the type of oven in your possession.

#### DIGITAL Version:

STEP	ACTION	IMAGE
1	Switch on the device by pressing the O/I main switch. <b>Note:</b> at start-up the green light on the button turns on and the "stAnd by" writing appears on the display.	

#### MECHANICAL Version:

STEP	ACTION	IMAGE
1	Switch on the device by rotating the time knob. <b>Note:</b> when switching on the oven the "ON" green indicator light turns on.	

## 8.3. PRODUCT LOADING AND COOKING



**Do not leave the oven operating without containers or with empty containers.**

### 8.3.1. PRODUCT LOADING







For cooking operations, place the tray on the grid inside the cooking chamber.

Only use trays and accessories specifically designed for this use, made with materials resistant to high temperatures and suitable for contact with food.



### 8.3.2. SET A COOKING

To **set a cooking**, proceed as described below according to the model in your possession.

#### DIGITAL Version:









STEP	ACTION
1	Press button  for 2s to enable the oven operating cycle. <b>Note:</b> the cooking temperature appears on the display (in °C).
2	Press buttons  to adjust the cooking temperature.
3	Press buttons  to adjust the cooking time.  Press button  to start the pre-heating of the oven. <b>Note:</b> the writing "PrEr iScA cALd" appears on the display for a few seconds, then the temperature appears in real time accompanied by the writing "PrE". <b>IT is forbidden to put items in the oven during the pre-heating phase!</b> Time and temperature can be changed during the pre-heating phase.
5	Press button  again to skip the pre-heating phase. <b>Note:</b> the oven passes to the cooking phase.
6	To end cooking press button  .

**MECHANICAL Version:**

STEP	ACTION	IMAGE
1	Rotate the time knob to adjust the cooking time. <b>Note:</b> in position  the oven stays on without time limitations.	
2	Rotate the temperature knob to adjust the cooking temperature. <b>Note:</b> the resistance light switching on indicates that the desired temperature is about to be reached. Once reached, the light switches off.	





### 8.3.3. NEW RECIPE CREATION (ONLY “DIGITAL” VERSION)

To **create a new recipe**, proceed as described below according to the model in your possession.  
The oven can be used to memorise a maximum of 10 recipes.

STEP	ACTION
1	Press button  from the “Stand by” mode. <b>Note:</b> the writing “r 1”, appears on the display, indicating the recipe number.
2	Then the recipe parameters are displayed (temperature / time - humidity ON/OFF),
3	Press button  to access the recipe parameters.
4	Press buttons  or  to adjust the cooking temperature.
5	Press buttons  or  to adjust the cooking time.
6	Press button  to activate/deactivate the humidity function and set the desired parameters.
7	Press button  for a few seconds to memorise the recipe. <b>Note:</b> the writing “done” appears on the display





### 8.3.4. COOKING WITH RECIPE ALREADY SAVED (ONLY “DIGITAL” VERSION)

To **set a cooking using a saved recipe**, proceed as described below according to the model in your possession.

STEP	ACTION
1	Press button  from the “Stand by” mode. <b>Note:</b> the writing “r 1”, appears on the display, indicating the recipe number. Then the recipe parameters are displayed (temperature / time - humidity ON/OFF),
2	Press buttons  or  to scroll the memorised recipes.
3	Press button  to select the recipe.





### 8.3.5. H<sub>2</sub>O INJECTION ADJUSTMENT (ONLY “DIGITAL” VERSION)

To **adjust the insertion of water in the cooking phase**, proceed as described below.

STEP	ACTION
1	During the programming phase, press the button 
2	The writing “H2O” appears on the left hand display, the right hand display shows the injection percentage.
3	Press buttons  or  to adjust the injection percentage from <b>OFF</b> = off to <b>100</b> = maximum.
4	Press button  during the cooking phase to manually inject water.

### 8.3.6. COOKING WITH CORE PROBE AND $\Delta^{\circ}\text{T}$ (ONLY “DIGITAL” VERSION)





To set the cooking mode with core probe and  $\Delta^{\circ}\text{T}$ , proceed as described below.

STEP	ACTION
1	In the manual parameters setting, press the button 
2	The right hand display changes from showing the cooking time to showing the probe temperature and the letter “c” appears next to it, showing the core temperature
3	Press buttons  or  to set the temperature to be reached by the probe for the oven to stop cooking.
4	When button  is activated again, the oven passes from differential cooking in “ $\Delta^{\circ}\text{T}$ ” mode indicated by letter “d” In this mode, the left display changes from showing the absolute temperature to showing the “ $\Delta^{\circ}\text{T}$ ” (temperature value which is added to the core temperature detected by the probe during the cooking phase). The end of cooking is determined by the value set and detected at the core of the product by the probe.

## 8.4. OTHER FUNCTIONS

### DIGITAL Version:

#### Automatic Humidity Function

- If the “Humidity” function (optional) is present, press button  to activate the automatic humidity function. The writing “H2O OFF” appears on the display
- Press buttons  or  to increase the humidity by 10% increments.
- To deactivate the automatic humidity function, press button  until the writing “OFF” appears on the display.

#### Manual Humidity Function

- The “Humidity” function can be used during cooking, if necessary. Press button  to give a single impulse to the augers inside the oven.

#### Switching cooking chamber lighting on/off

- Press button  to switch the cooking chamber lighting on or off during all phases.

### MECHANICAL Version:

- If the “Humidity” function is present (optional), press the light blue button on the control panel. Pressing the buttons gives an impulse to the nozzle which inputs humidity in the oven.

## 8.5. SWITCHING OFF

To **switch off the oven**, proceed as described below according to the model in your possession.

### DIGITAL Version:

STEP	ACTION	IMAGE
1	Press the O/I main switch. <b>Note:</b> the button is no longer green and the display switches off.	

### MECHANICAL Version:

STEP	ACTION	IMAGE
1	Switch off the device by rotating the time knob to "0". Also rotate the temperature knob on "0". <b>Note:</b> the "on" indicator light switches off.	



## 9. CLEANING

### 9.1. CLEANING SAFETY WARNINGS



**Disconnect the power supply before any cleaning operation.  
Turn off the proximity switch.**



**Wait for the oven to cool down before performing cleaning operations.**

- The oven must be cleaned after every use.
- It is recommended to have specialised personnel carry out at least the first oven cleaning.
- Clean the equipment regularly to avoid deterioration of the materials of which its surface is made.
- Do not use water jets and/or high pressure lances to wash the internal and external parts of the oven since the electrical parts could be damaged. Electrical shock hazard!
- At the end of every cooking cycle, extract the grids or the trays, clean and dry all the internal and external parts of the oven using only warm water and non aggressive detergents making sure to dry all the damp parts with a soft cloth.



**Carry out the cleaning operations using work gloves.**



**Do not use products that contain chlorine, its diluted solutions, caustic soda, abrasive cleaners, muriatic acid, bleach or other products that may scratch or sand.**



**Do not use a steam cleaner to clean the equipment.**

## 9.2. CLEAN THE COOKING CHAMBER

After every cooking process, the cooking chamber (muffle) must be cleaned from any food residue and grease, according to the use of the oven.

**To clean the oven, use a suitable degreasing product,** respecting its indications, instructions for use and warnings. Rinse with a sponge soaked in water.

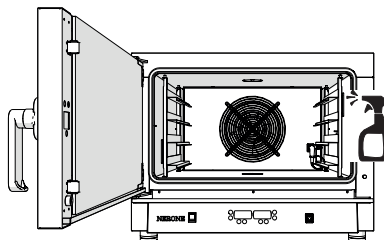

Also keep in mind that to clean the cooking chamber, the oven may be started and reach cooking temperature; therefore pay attention to the following:

- Open the hot oven carefully, minding uncovered body parts and the eyes.
- Remove the grids or trays and clean them separately

## 9.3. CLEANING THE GLASS



**Clean the glass only once it has completely cooled.**



**Do not use abrasive material such as scotch bryte scourer, metal sponges or other materials that may compromise the transparency of the glass and/or cause it to break.**

**To clean the glass (internal and external) use a suitable degreasing product,** respecting its indications, instructions for use and warnings. Rinse with a sponge soaked in water.

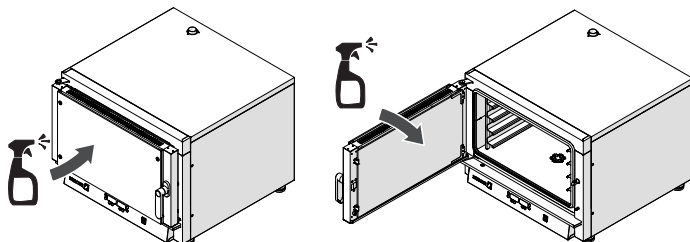

## 9.4. SPECIAL CLEANING OF THE COOKING CHAMBER

After 15 hours of use, the chamber requires deeper cleaning.

To perform **special cleaning on the cooking chamber**, proceed as described:

STEP	ACTION
1	Open the oven door.
2	Disassemble the tray support (as indicated in paragraph “ <b>TRAY SUPPORTS DISASSEMBLY</b> ”).
3	Unscrew the central screw that fastens the protection of the fans with a no.5 Allen wrench .
4	Carefully remove the fan guards (fan casing).
5	Clean the surfaces with a suitable de-greasing product. Rinse thoroughly with a sponge soaked in water.

1

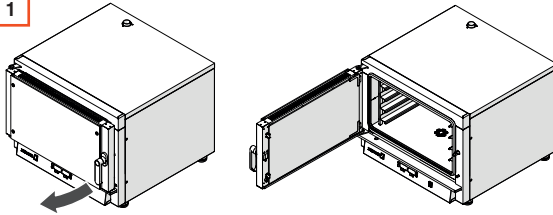

3

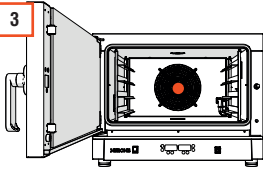

4

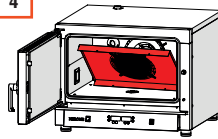

5

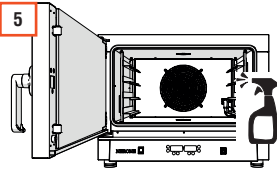

## 10. MAINTENANCE



**Disconnect the power supply before any maintenance operation.  
Turn off the proximity switch.**



**Always wait for the oven to cool down before performing maintenance operations.**



**Maintenance work must be carried out by a qualified technician.**

### 10.1. ROUTINE MAINTENANCE

Ensure smooth operation over time of the equipment by performing periodic/preventive checks and maintenance.

#### 10.1.1. INSPECTING AFTER DELIVERY

The following table lists a series of controls and activities that need to be carried out according to the recommended frequency.

OPERATION	FREQUENCY			
	WEEKLY	MONTHLY	AT 6-MONTHLY INTERVALS	YEARLY
Make sure that the door closes properly.			■	
Check the integrity of the gasket on the door and that it is not flattened.			■	
Check the proper operation of the fans.			■	
Check the correct operation of the lamp.				
Check the integrity of the electrical system			■	
Check the correct operation of the fan.			■	

### 10.2. EXTRAORDINARY MAINTENANCE

**Special maintenance** includes service, repair, and restoration of nominal operating conditions or replacement of a faulty, defective or worn component.

### 10.2.1. DOOR DISASSEMBLY FOR MAINTENANCE OPERATIONS



**Pay attention when removing the door of the device. The door is heavy!**

The oven door can be disassembled to facilitate some maintenance operations.

After removing the door, place it carefully on a surface.

To **disassemble the door**, proceed as described:

STEP	ACTION
1	Open the door all the way.
2	Unscrew the 2 door holding pins and then remove it using a large flat head screwdriver.
3	Remove the doors from the seats of the hinges.
4	To reassemble the door, perform this procedure in reverse order.

1

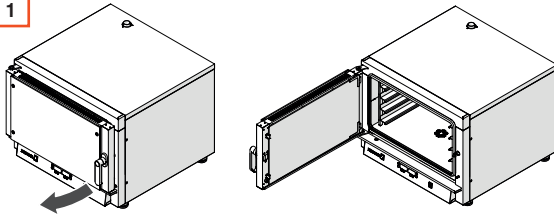

2

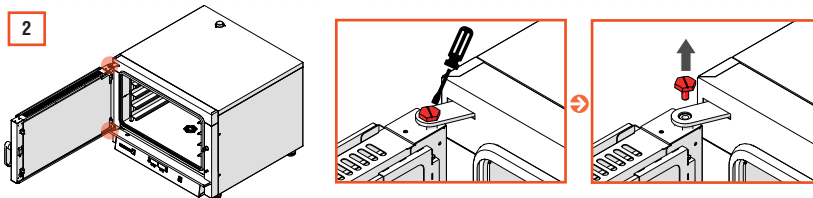

3

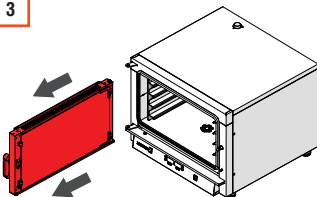

## 10.2.2. DOOR GASKET REPLACEMENT

To **replace the gasket** on the door, proceed as follows:

STEP	ACTION
1	Open the door all the way.
2	Gently pull out one corner of the gasket and remove it from the housing.
3	Replace the gasket with one that has the same characteristics.
4	Close the oven door.

1

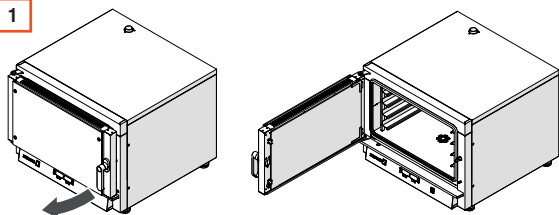

2

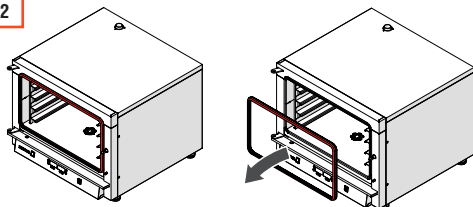

### 10.2.3. INTERNAL GLASS DISASSEMBLY / REPLACEMENT

The internal glass can be removed to facilitate cleaning operations or in case of damage.



**In case of damage, recover the glass shards without releasing them in the environment. Handle with care to avoid cuts.**

To perform the **disassembly / replacement of the internal glass** proceed as described:

STEP	ACTION
1	Open the door all the way.
2	Unhook the two spring stops of the internal glass.
3	Open the internal glass like a book with respect to the door.
4	Slowly remove the internal glass and clean and/or replace it with one possessing the same features.
5	To reassemble the internal glass, perform this procedure in reverse order.

1

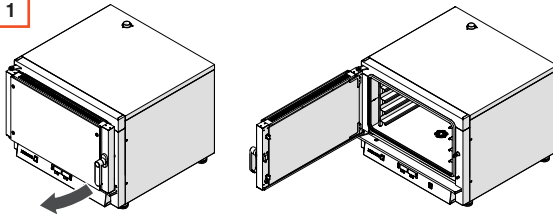

2

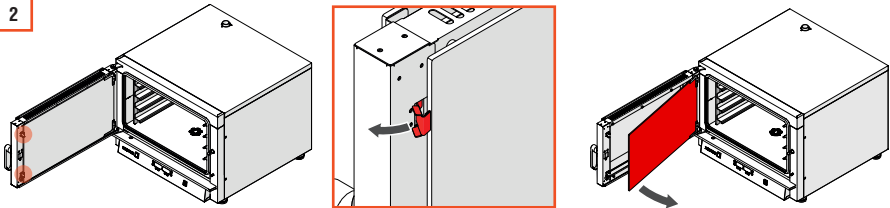

3

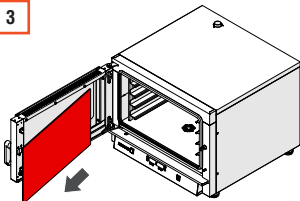

## 10.2.4. TRAY SUPPORTS DISASSEMBLY

To **disassemble the tray supports**, proceed as follows:

STEP	ACTION
1	Open the door all the way.
2	Unscrew the 4 fixing screws of the support.
3	Extract the support from the cooking chamber.
4	Repeat the operation for the opposite support if necessary.
5	To reassemble the support, perform this procedure in reverse order.

1

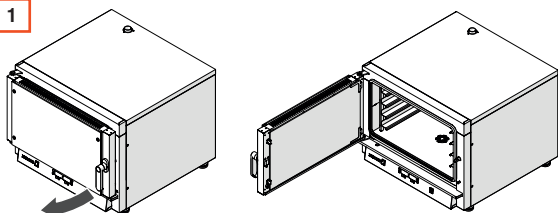

2

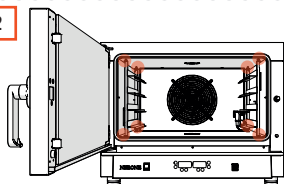

3

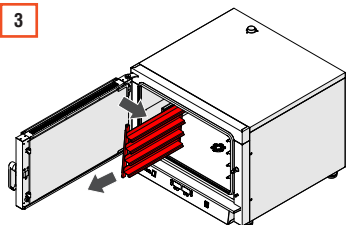



## 10.2.5. LAMP REPLACEMENT



**Do not start the oven without repositioning the lamp-cover.**

**Danger of electrical shocks or burns!**

Only use lamps with the same technical specifications. Place a cloth on the lower internal part of the oven, to protect the lamp in case it falls.

Proceed as described to **replace the lamp**:

STEP	ACTION
1	Open the door all the way.
2	Disassemble the tray support on the side of the lamp to be replaced (as indicated in paragraph “ <b>TRAY SUPPORTS DISASSEMBLY</b> ”).
3	Remove the glass cover of the lamp, unscrewing the 4 fixing screws with a Philips screwdriver.
4	Unhook the lamp and remove it.
5	Replace the lamp with a new one having the same characteristics. <b>Note:</b> the lamp must be suitable for high temperatures.
6	To reassemble the lamp, perform this procedure in reverse order.

1

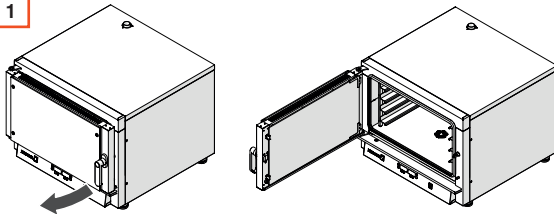

3

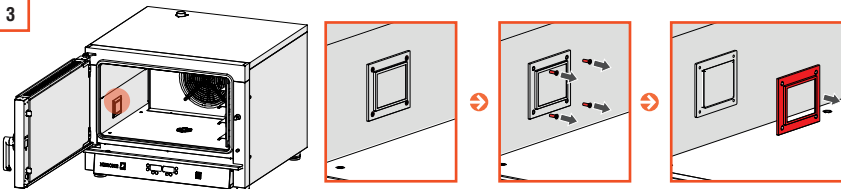

4

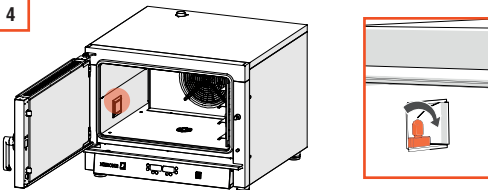

# 11. DIAGNOSTICS

## 11.1. PROBES ALARM

An alarm is generated when one of the probes is outside the nominal operating field or in case of open or shorted probe. The alarm condition is indicated by showing the following error codes on the display:

- PR1 = Faulty chamber probe
- PR3 = Faulty board probe

The alarm LED is activated.

## 11.2. ACTIONS ON THE ADJUSTMENT IN PROGRESS

### ACTIONS ON THE ADJUSTMENT IN PROGRESS

CHAMBER PROBE	<p>The error condition of the chamber probe causes the following actions:</p> <ul style="list-style-type: none"> <li>▪ code PR1 shown on the display</li> <li>▪ oven disabling</li> </ul> <p>When the faulty chamber probe condition ceased, the adjustments resumes normally.</p>
BOARD PROBE	<p>The error condition of the board probe causes the following actions:</p> <ul style="list-style-type: none"> <li>▪ code PR3 shown on the display</li> <li>▪ total deactivation of board and oven</li> </ul>



**When the faulty board probe condition ceases, adjustment DOES NOT resume normally, the button must be used to switch off the oven.**

## 11.3. SIGNALS

CODE	MEANING
PR1	probe 1 error
PR2	probe 2 error
PR3	probe 3 error

## 12. DECOMMISSIONING AND DISPOSAL

### 12.1. LONG PERIODS OF INACTIVITY

If the appliance is not to be used for a long period of time (more than 2-3 weeks) proceed as follows:

STEP	ACTION
1	Disconnect the electric power supply.
2	Clean the equipment thoroughly (see chapter "CLEANING").
3	Cover the oven with a cloth.

### 12.2. DISPOSAL



**The electrical and electronic equipment that make up the appliance, such as lamps, electronic controls, electrical switches, electric motors and other electrical material in general, must be disposed of and/or recycled separately from urban waste according to the procedures of the regulations in force on the subject in each country. Avoid dispersing the materials in the environment. Furthermore, all materials that make up the product such as sheet metal, plastic, rubber, glass and more, must be recycled and/or disposed of in accordance with the procedures of the relevant regulations in force.**

**Illegal or incorrect disposal of the equipment entails application of the sanctions required by the current legislation.**

Comply with the regulations in force in the Country of installation. Make the equipment, destined for dismantling, unusable by removing the power supply cables.

